

vtech®

User's manual

www.vtechphones.com



Models:

DS6671-2/DS6671-3/
DS6671-4/DS6672-4/
DS667V-2F/DS667V-2G/
DS667V-2H/DS667V-2J

 **Bluetooth®**



DECT 6.0

Congratulations

on purchasing your new VTech product. Before using this telephone, please read **Important safety instructions** on page 94 of this manual.

This manual has all the feature operations and troubleshooting necessary to install and operate your new VTech telephone. Please review this manual thoroughly to ensure proper installation and operation of this innovative and feature rich VTech product. For support, shopping, and everything new at VTech, visit our website at www.vtechphones.com. In Canada, please visit www.vtechcanada.com.



Telephones identified with this logo have reduced noise and interference when used with most T-coil equipped hearing aids and cochlear implants. The TIA-1083 Compliant Logo is a trademark of the Telecommunications Industry Association. Used under license.

Register online to get an additional 3-month warranty!
Visit www.vtechphones.com.



Registration

Register your product online for enhanced warranty support.



Product news

Learn about the latest VTech products.

The *Bluetooth*[®] word mark and logos are owned by Bluetooth SIG, Inc. and any use of such marks by VTech Holdings Limited is under license. VTech Holdings Limited is a member of Bluetooth SIG, Inc. Other trademarks and trade names are those of their respective owners.

Table of contents

Getting started	1
Parts checklist	1
Telephone base and charger installation	2
Handset battery installation	3
Handset battery charging	4
Headset charging	5
Headset battery	6
Earbud installation	7
Ear hook installation	8
Head band installation	11
Are you a new cable or VoIP subscriber?	13
Did you subscribe to voicemail service from your telephone service provider?	14
Handset layout.....	15
Telephone base layout.....	18
Headset layout.....	20
Bluetooth	21
Introducing Bluetooth.....	21
Glossary of terms	23
Bluetooth setup.....	24
VTech Connect to Cell™ application ...	24
Add a cell phone	25
Auto connection	26
Connect a paired cell phone	26
Disconnect a paired cell phone	26
Cell ringer (Ringtone Share).....	26
Download phonebook.....	27
Telephone settings	28
Using the menu	28
Handset ringer volume	29
Telephone base ringer volume	29
Headset ringer volume	29
Ringer tone	30
Quiet mode	30
Set date and time	31
LCD language.....	32
Voicemail number	33
Clear voicemail indicators.....	34
Key tone.....	34

CID time synchronization.....	35
Dial mode	35

Telephone operation

Telephone operation	36
Make a home call	36
Redial a home call	36
Answer a home call	36
End a home call.....	36
Call waiting on the home line.....	36
Make a cell call	37
Answer a cell call	37
End a cell call	37
Call waiting on the cell line	38
Answer a cell call while on a home call.....	38
Cell phone voicemail	38
Answer a home call while on a cell call	38
Handset speakerphone	38
Volume control.....	39
Mute.....	39
Hold	39
Redial	40
Website.....	40
Temporary ringer silencing	41
Chain dialing.....	41
Temporary tone dialing	42
Find handset.....	42
Check voicemail.....	42

Multiple handset use

Multiple handset use	43
Join a call in progress.....	43
Intercom.....	44
Answer an incoming call during an intercom call	45
Transfer a call using intercom	46
Push-to-talk (PTT)	47
PTT to a single handset.....	48
PTT to multiple handsets.....	49
Answer a PTT call.....	50
Change a one-to-one PTT call to an intercom call	50
End a PTT call	51
Answer an incoming call during a PTT call	51

Table of contents

Make an outgoing call during a PTT call	51
--	----

Phonebook 52

About the phonebook	52
Add a phonebook entry to the home phonebook	53
Review phonebook entries	55
Alphabetical search	55
Dial a phonebook entry	56
Edit a phonebook entry	56
Delete a phonebook entry	57
Remove an entire cell phonebook	57

Caller ID 58

About caller ID	58
Information about caller ID with call waiting.....	58
Caller ID log.....	59
Memory match.....	59
Missed call indicator	60
Review the caller ID log.....	60
View dialing options.....	61
Dial a caller ID log entry	62
Save a caller ID log entry to the home phonebook	62
Delete caller ID log entries	63
Caller ID log screen messages.....	63

Answering system settings... 64

Answering system	64
Announcement	64
Record your own announcement.....	64
Play your announcement.....	64
Delete your announcement	65
Answer on/off.....	65
Call screening.....	66
Number of rings	66
Remote access code	67
Message alert tone.....	67
Recording time	68

Answering system

operation 69

Answering system and voicemail.....	69
-------------------------------------	----

Using the answering system and voicemail together	69
Message capacity.....	70
New message indication.....	70
Call screening.....	70
Call intercept.....	71
Temporarily turn off the message alert tone	71
Message playback.....	72
Delete all old messages	73
Record, play and delete memos.....	73
Remote access.....	74

Appendix 75

Expand your telephone system	75
Message window displays	76
Screen messages.....	77
Handset and telephone base indicators.....	79
Headset indicators.....	81
Troubleshooting	82
Important safety instructions	92
Battery	93
Precautions for users of implanted cardiac pacemakers	93
Operating range.....	93
ECO mode.....	93
Maintenance	94
About cordless telephones	94
The RBRC® seal	95
FCC, ACTA and IC regulations	96
California Energy Commission battery charging testing instructions.....	98
For C-UL compliance only	99
Limited warranty	101
Technical specifications	103

Index 104

Getting started

Parts checklist

Your telephone package contains the following items. Save your sales receipt and original packaging in case it is necessary to ship your telephone for warranty service.



Ear hooks (3)



Ear pad



Additional earbuds (3)



Telephone line cord



Cordless headset with an earbud attached



Handset

(1 for DS6671-2/DS667V-2F/
DS667V-2G/ DS667V-2H/
DS667V-2J)
(2 for DS6671-3)
(3 for DS6671-4/ DS6672-4)



Head band

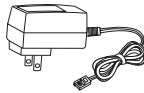

Telephone base power adapter

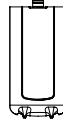

Handset battery compartment cover

(1 for DS6671-2/DS667V-2F/
DS667V-2G/ DS667V-2H/
DS667V-2J)
(2 for DS6671-3)
(3 for DS6671-4/DS6672-4)



Handset battery

(1 for DS6671-2/DS667V-2F/
DS667V-2G/ DS667V-2H/
DS667V-2J)
(2 for DS6671-3)
(3 for DS6671-4/DS6672-4)

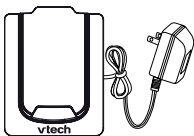

Handset charger and charger adapter

(1 for DS6671-3)
(2 for DS6671-4/DS6672-4)

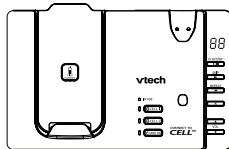

Telephone base

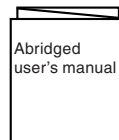

Abridged user's manual



Quick start guide

note

- The headset battery is not replaceable.
- To purchase replacement batteries or power adapters, visit our website at www.vtechphones.com or call 1 (800) 595-9511. In Canada, go to www.vtechcanada.com or dial 1 (800) 267-7377.

Getting started

Telephone base and charger installation

Install the telephone base and handset charger(s) as shown below.

Make sure that the electrical outlet is not controlled by a wall switch.

If you subscribe to digital subscriber line (DSL) high-speed Internet service through your telephone line, you must install a DSL filter between the telephone line cord and the telephone wall jack. The filter prevents noise and caller ID problems caused by DSL interference. Contact your DSL service provider for more information about DSL filters.

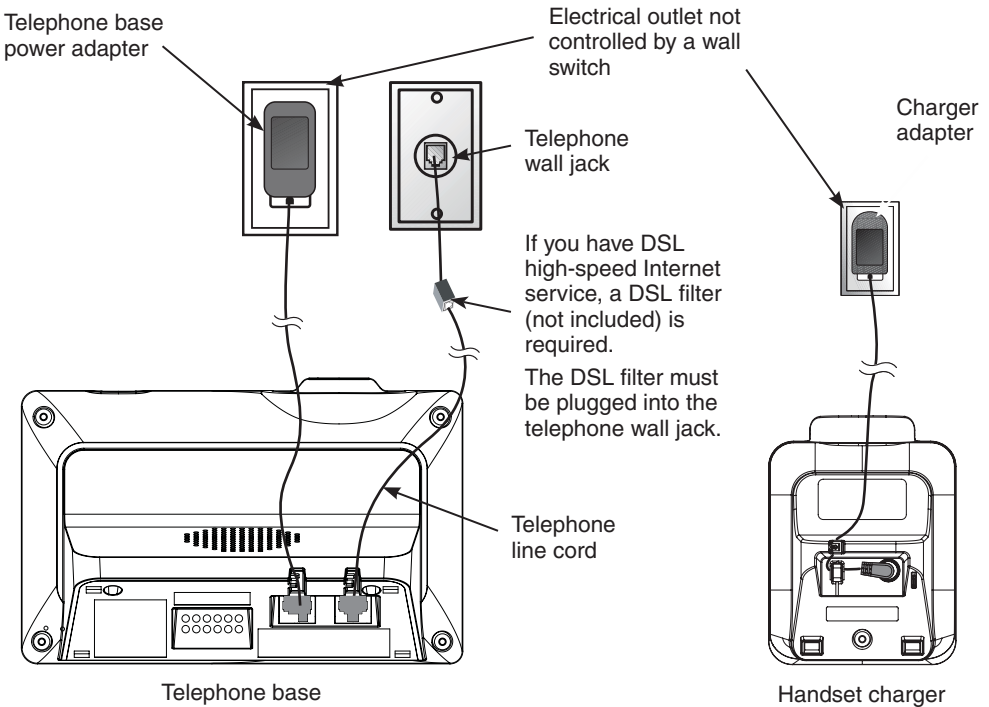

note

- Use only the power adapters supplied with this product. To order a replacement, visit our website at www.vtechphones.com or call 1 (800) 595-9511. In Canada, go to www.vtechcanada.com or call 1 (800) 267-7377.
- The power adapters are intended to be correctly oriented in a vertical or floor mount position. The prongs are not designed to hold the plug in place if it is plugged into a ceiling, under-the-table or cabinet outlet.
- Even if you do not subscribe to any conventional telephone service, you can still use the cell line alone without plugging in a telephone line cord.

CAUTION:

If you subscribe to telephone service from a cable company or a VoIP service provider, contact your cable/VoIP service provider for more information.

Getting started

Handset battery installation

Install the battery as shown below.

1. Plug the battery connector securely into the socket inside the handset battery compartment, matching the orientation of the engraved label.
2. Place the battery with the label **THIS SIDE UP** facing up and the wires inside the battery compartment.

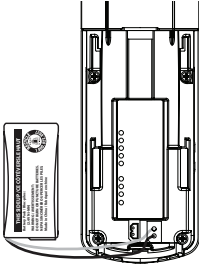

3. Align the cover flat against the battery compartment, then slide it towards the center of the handset until it clicks into place.
4. Charge the handset by placing it in the telephone base or handset charger. The **CHARGE** light is on when the handset is charging.

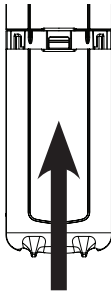

CHARGE light remains on when charging.

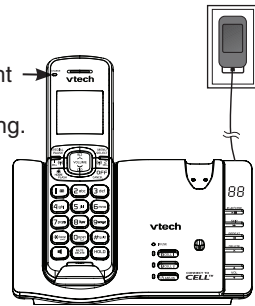

note

- If the handset will not be used for a long time, disconnect and remove the battery to prevent possible leakage.
- To purchase replacement batteries, visit our website at www.vtechphones.com or call **1 (800) 595-9511**. In Canada, go to www.vtechcanada.com or dial **1 (800) 267-7377**.

IMPORTANT:

Check for a dial tone by pressing **HOME**, **CELL 1** or **CELL 2**. If you hear a dial tone, the installation is successful.

If you do not hear a dial tone:

- Make sure the installation procedures described above are properly done.
- It may be a wiring problem. If you have changed your telephone service to digital service from a cable company or a VoIP service provider, the telephone line may need to be rewired to allow all existing telephone jacks to work. Contact your cable/VoIP service provider for more information.



Getting started

Handset battery charging

Once you have installed the battery, the handset LCD display indicates the battery status (see the table below).

NOTES

- For best performance, keep the handset in the telephone base or charger when not in use.
- The battery is fully charged after 12 hours of continuous charging.
- If you place the handset in the telephone base or the charger without plugging in the battery, the screen displays **No battery**.

Battery indicators	Battery status	Action
The screen is blank, or displays Place in charger and  flashes.	The battery has no or very little charge. The handset cannot be used.	Charge without interruption (about 30 minutes).
The screen displays Low battery and  flashes.	The battery has enough charge to be used for a short time.	Charge without interruption (about 30 minutes).
The screen displays HANDSET X .	The battery is charged.	To keep the battery charged, place it in the telephone base or handset charger when not in use.

When it is fully charged, you can expect the following performance:

Operation	Operating time
While in handset use (talking*)	Seven hours
While in speakerphone mode (talking*)	Three hours
While not in use (standby**)	Five days

* Operating times vary depending on your actual use and the age of the battery.

** Handset is not charging or in use.

After you install your telephone or power returns following a power outage, the handset will prompt you to set the date and time.

For instructions, see **Set date and time** on page 31.

To skip setting, press **CANCEL**.





Getting started

Headset charging

After installing the telephone base, charge the headset as shown below. The headset is fully charged after three hours of continuous charging. If the  light does not turn on while charging, you need to charge the headset without interruption for at least 15 minutes to give the headset enough charge to use for a short time. For best performance, keep the headset in the telephone base when not in use.

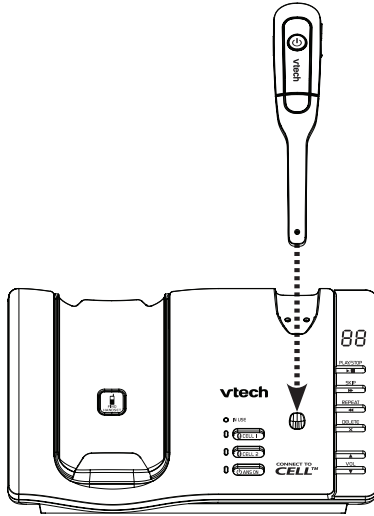
1. Place the tip of the headset in the small cradle on the telephone base.



2. The magnet holds the top of the headset in place. The  light turns on when charging.

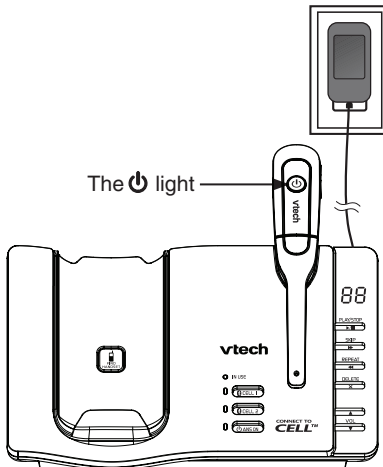

Getting started

Headset battery

It takes up to three hours for the battery to be fully charged. When it is fully charged, you can expect the following performance:

Operation	Operating time
While in use (talking*)	Nine hours
While not in use (standby**)	Ninety hours

* Operating times vary depending on your actual use and the age of the battery.

** Headset is not charging or in use.

The battery needs charging when:

- The headset beeps twice every 20 seconds.
- The 🔌 light is off when in idle mode.
- The 🔌 light flashes every 10 seconds in red.

Conserve battery life:

To reduce the risk of fire or injury, read and follow these instructions:

- The headset battery is not replaceable.
- If the headset will not be used for a long period of time, press and hold on the headset to power off the headset and conserve the headset battery life. The 🔌 light flashes three times in red when the headset is being powered off.

CAUTION:

To prevent fire or shock hazard, do not expose this product to water or any type of moisture.

Getting started

Earbud installation

There are four earbuds provided and one of them has already been attached to the headset.

To remove the earbud from the headset earpiece:

Hold both sides of the earbud and then pull the earbud until it separates from the earpiece.

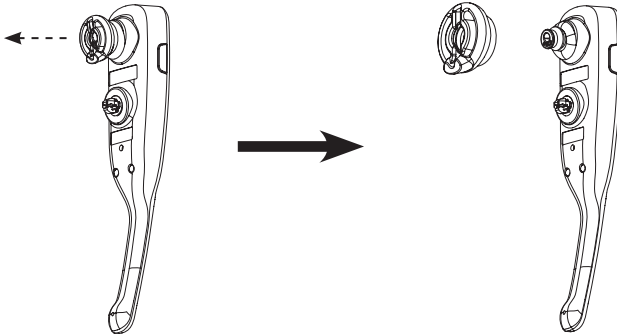

To attach the earbud to the headset earpiece:

1. Choose an appropriate earbud.
2. Press the earbud towards the earpiece until it clicks into place. Move the earbud around so that the protruding bump on the earbud is pointing towards your mouth when placed on your ear. The protruding bump on the earbud holds the headset securely in your ear.

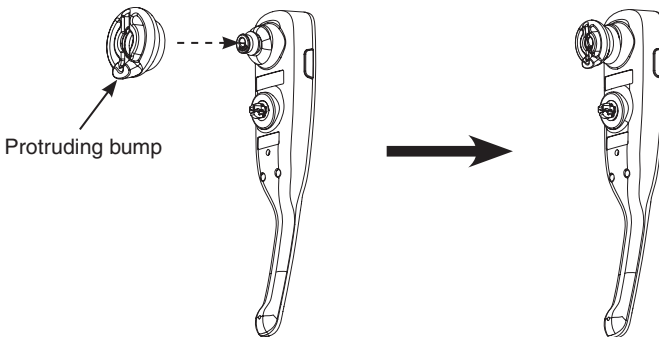

Getting started

Ear hook installation

There are three ear hooks provided. The smallest ear hook is a flexible ear hook. If you choose to use it, adjust to suit your ear comfortably before use.

To attach the ear hook to the headset:

1. Remove any headset attachment (earbud excluded) connected to the headset.
2. Choose an appropriate ear hook.
3. Insert the ear hook [A] into the rotating clip [B] on the headset until it clicks into place.

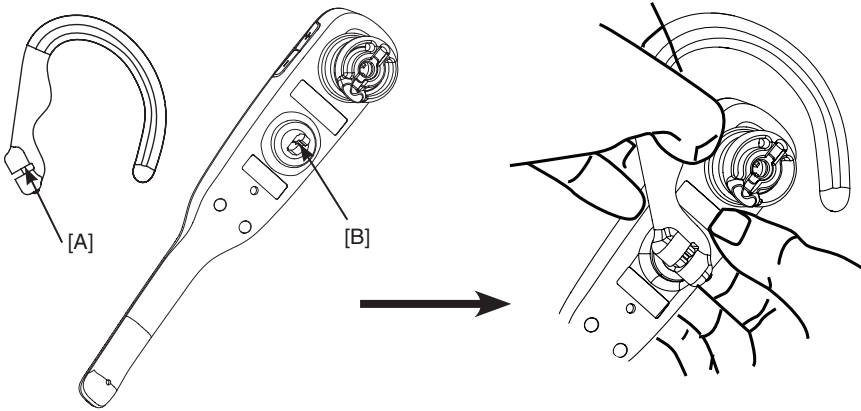

4. Hook the headset on your right ear. Adjust the angle of the headset until the microphone is pointing towards your mouth. Firmly grip the earpiece with one hand whenever adjusting the headset microphone up or down.

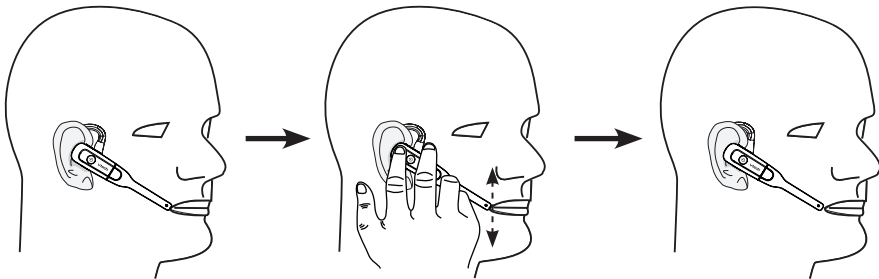

Getting started

Ear hook installation

To adjust the headset to wear on your left ear:

1. Hold the headset with one hand. Lift the ear hook upward.

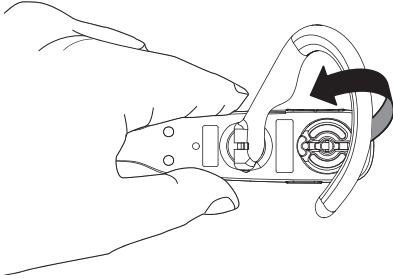

2. Twist the ear hook 180 degrees clockwise.

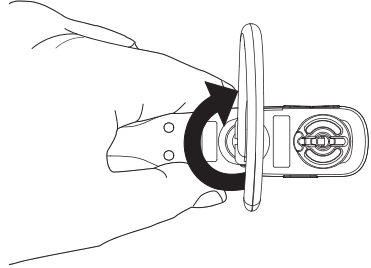

3. Push the ear hook downward.

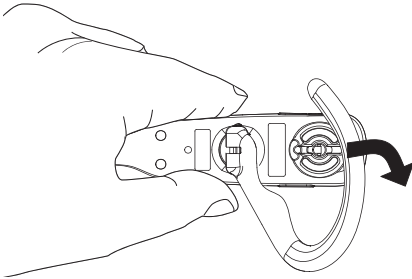

4. Hook the headset on your left ear. Adjust the angle of the headset until the microphone is pointing towards your mouth.

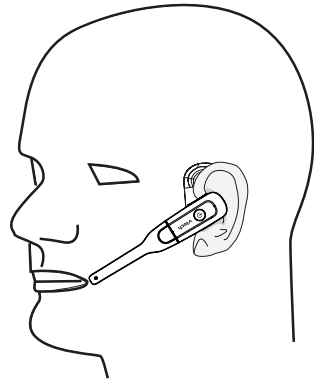

Getting started

Ear hook installation

To remove the ear hook from the headset:

1. Hold the headset with one hand and the ear hook with your other hand.
2. Pull the end of the ear hook up until it separates from the rotating clip on the headset.

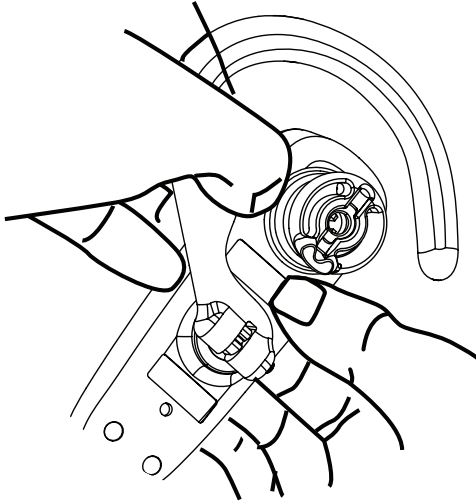

Getting started

Head band installation

To attach the head band to the headset:

1. Remove any headset attachment connected to the headset.
2. Attach the ear pad to the headset earpiece.

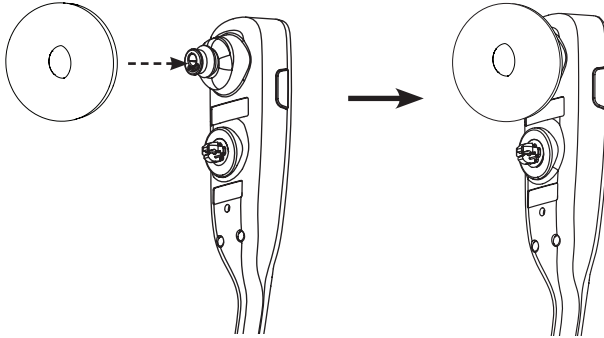

3. To wear the headset on your right ear, insert the end [A] of the head band into the rotating clip [B] on the headset until it clicks into place.

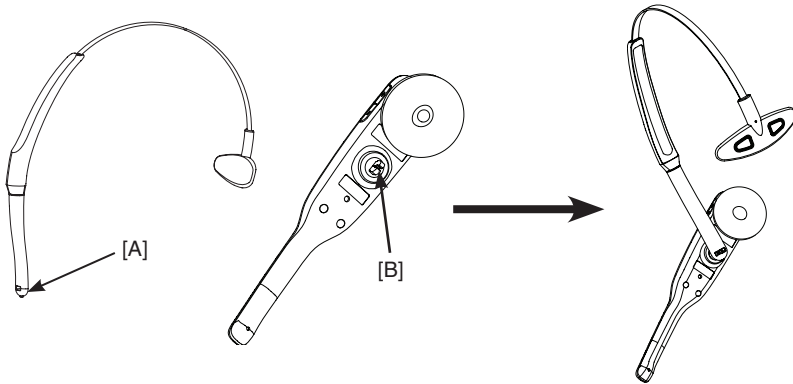

Getting started

Head band installation

4. Adjust the head band to fit your head. Adjust and rotate the angle of the headset until the microphone is pointing towards your mouth. Firmly grip the earpiece with one hand whenever adjusting the headset microphone up or down.

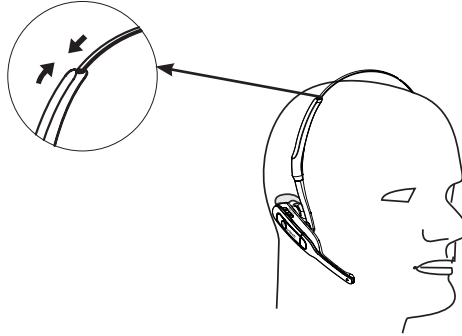

note

To wear on your left ear, hold the headset on one hand and the head band with your other hand. Rotate the head band within the rotating clip on the headset.

To remove the head band from the headset:

1. Hold the headset with one hand and the head band with your other hand.
2. Pull the end of the head band until it separates from the rotating clip on the headset.

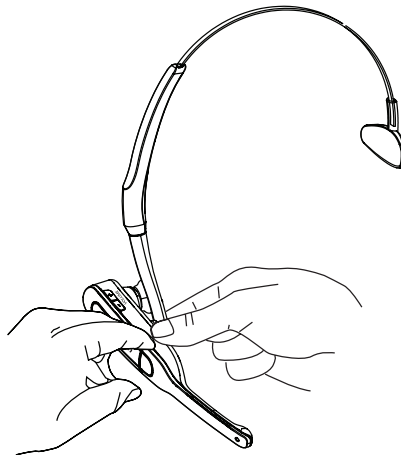

Getting started

Are you a new cable or VoIP subscriber?

If your answer is **yes**, the existing telephone jacks in your home may no longer work. Your cable/VoIP service provider uses a different connection, separate from your old traditional telephone service, to connect the modem/router/terminal adapter installed in your home.

To allow all existing telephone jacks to work, contact your telephone service provider for solutions, such as rewiring services (fees may apply).

If your answer is **no**, your existing telephone jacks will continue to work as normal.

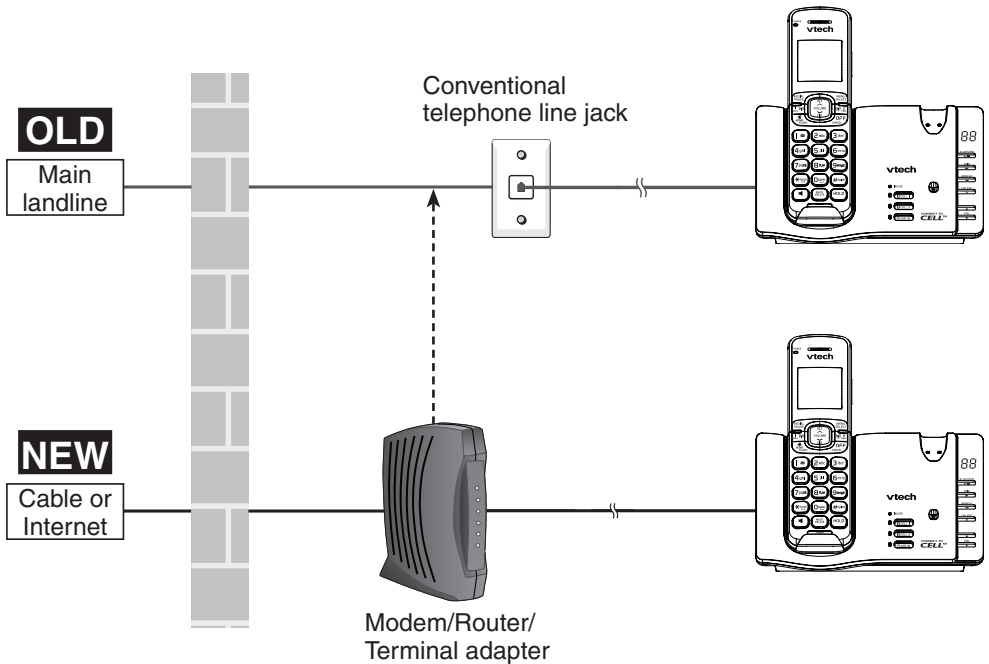

Getting started

Did you subscribe to voicemail service from your telephone service provider?

Your telephone has a built-in answering system and supports voicemail feature offered by your telephone service provider (subscription is required, and fees may apply). Refer to **Answering system and voicemail** on page 69 for more details.

To use the built-in answering system:

You may see this online **Complete user's manual** on how to record your outgoing announcement, retrieve messages and other related operations. You may also see the **Abridged user's manual** provided in the product package for abbreviated instructions.

To use the voicemail:

To retrieve your voicemail messages, you typically dial an access number provided by your telephone service provider, and then enter a security code. Contact your telephone service provider for instructions on how to configure the voicemail settings and listen to messages.

Getting started

Handset layout

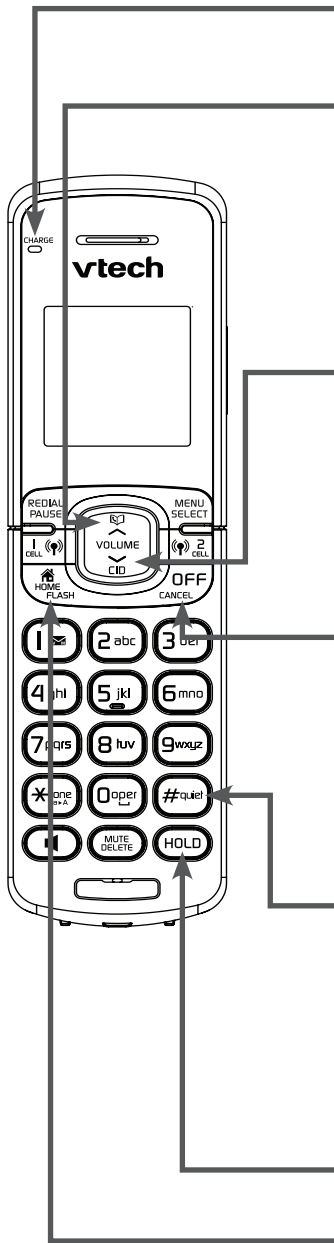

CHARGE light

- On when the handset is charging in the telephone base or handset charger (page 3).

VOLUME/☰/☷ (phonebook)

- Press to review the phonebook when the phone is not in use (page 55).
- Press to scroll up while in a menu, or in the phonebook, caller ID log or redial list.
- While entering names or numbers, press to move the cursor to the right.
- During a call or message playback, press to increase the listening volume (page 39 or 72).

VOLUME/☷/☰ (caller ID)

- Press to review the caller ID log when the phone is not in use (page 60).
- Press to scroll down while in a menu, or in the phonebook, caller ID log or redial list.
- While entering names or numbers, press to move the cursor to the left.
- During a call or message playback, press to decrease the listening volume (page 39 or 72).

OFF/CANCEL

- During a call, press to hang up (pages 36 and 37).
- While in a menu, press to return to the previous menu, or press and hold to return to idle mode, without making changes.
- While the phone is ringing, press to silence the handset ringer temporarily (page 41).
- Press and hold to erase the missed call indicator when the phone is not in use (page 60).

#quiet

- Press repeatedly to display other dialing options while reviewing a caller ID log entry (page 61).
- Press and hold to set and turn on the quiet mode, or to turn it off when the handset is not in use (page 30).
- While the phone is ringing, press to silence the handset ringer temporarily (page 41).
- While saving a caller ID log entry to the home phonebook, press to toggle name order (page 62).

HOLD

- Press to put current call on hold.

☎/HOME/FLASH

- Press to make or answer a home call (page 36).
- During a call, press to answer an incoming home call when you receive a call waiting alert (page 36).

Getting started

Handset layout

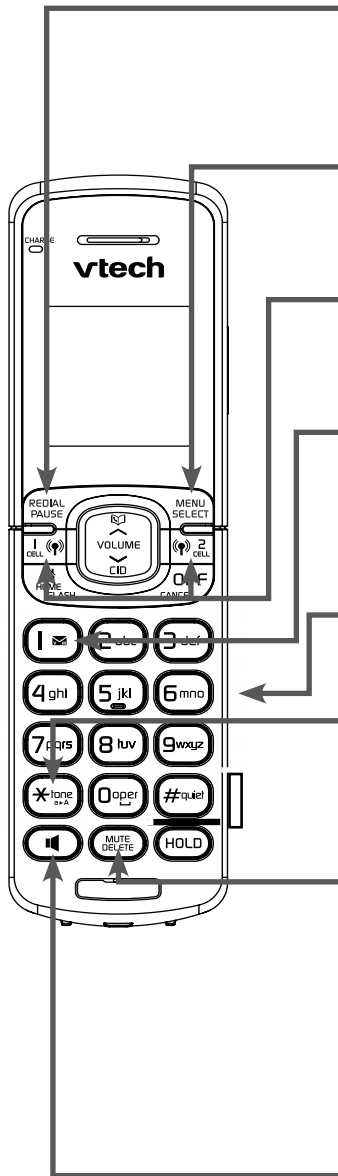

REDIAL/PAUSE

- Press repeatedly to view the last 10 numbers dialed (page 40).
- While entering numbers, press and hold to insert a dialing pause (pages 33, 53, 54 and 62).

MENU/SELECT

- Press to show the menu (page 28).
- While in the menu, press to select an item or save an entry or setting.

CELL 1/CELL 2

- Press to make or answer a cell call (page 37).
- During a cell call, press to answer an incoming cell call when you hear a call waiting alert (page 38).

1

- While reviewing a caller ID log entry, press repeatedly to add or remove 1 in front of the telephone number before dialing or saving it in the phonebook (page 61).
- Press and hold to set or dial your voicemail number when the phone is not in use (page 33).

Dialing keys

- Press to enter numbers or characters.
- Press to answer an incoming call (pages 36 and 37).

*tone/a▶A

- During a call, press to switch to tone dialing if you have pulse service (page 42).
- While entering characters, press to switch between upper case and lower case.

MUTE/DELETE

- During a call, press to mute the microphone (page 39).
- While the phone is ringing, press to silence the handset ringer temporarily (page 41).
- While reviewing the redial list, phonebook or caller ID log, press to delete an individual entry (page 40, page 57 and page 63 respectively).
- While using the dialing keys, press to delete digits, or press and hold to delete all digits.

(Speakerphone)

- Press to make or answer a call using the handset speakerphone (page 36).
- During a call or message playback, press to switch between the handset speakerphone and the cordless handset (page 38 or 72).

Getting started

Handset layout

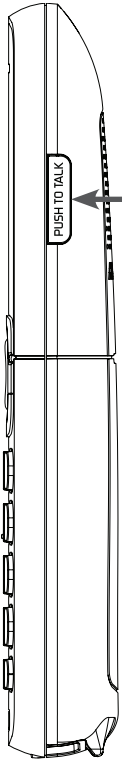

PUSH TO TALK (PTT)

- Press to begin a broadcast to one or multiple handsets (page 48 or page 49).
- Press and hold to broadcast to a group of handsets when the handset is not in use (page 49).

Getting started

Telephone base layout

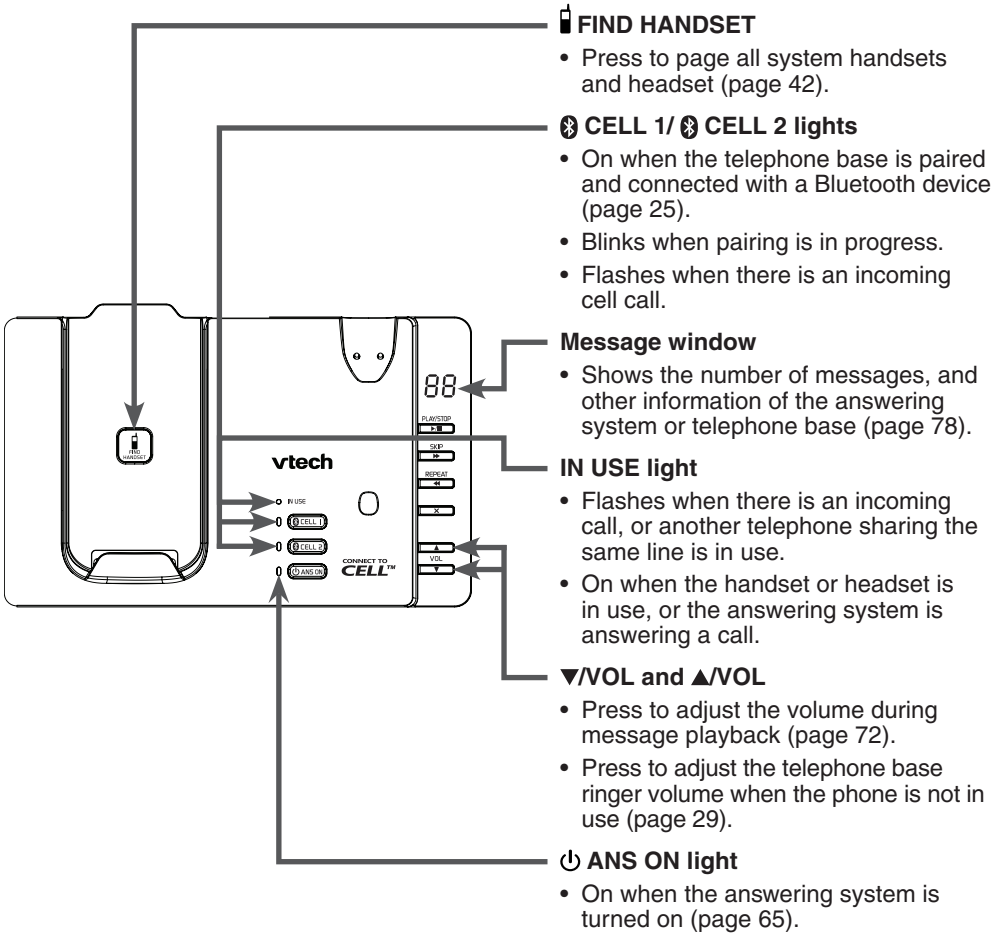

Getting started

Telephone base layout

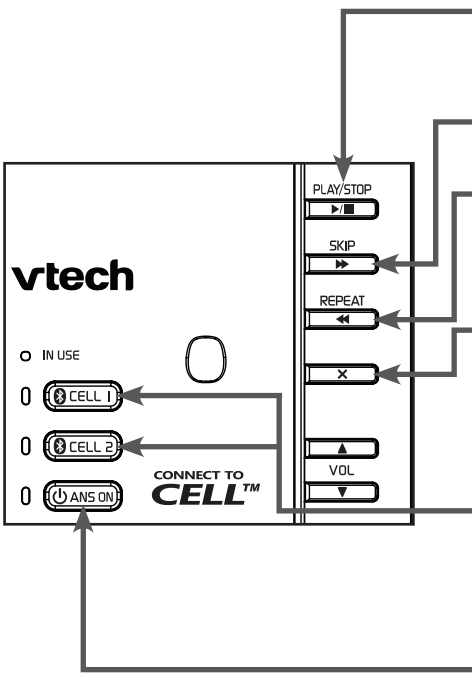

▶/■/PLAY/STOP

- Press to play messages (page 72).
- Press to stop message playback (page 72).

▶/■/SKIP

- Press to skip to the next message (page 72).

◀/■/REPEAT

- Press to repeat a message (page 72).
- Press twice to play the previous message (page 72).

X/DELETE

- Press to delete the playing message (page 72).
- When the phone is not in use, press twice to delete all previously reviewed messages (page 73).

☎ CELL 1/☎ CELL 2

- Press and hold to add or replace a cell phone (page 25).
- Press to manually connect the paired cell phone (page 26).

⏻ ANS ON

- Press to turn the answering system on or off (page 65).

Getting started

Headset layout

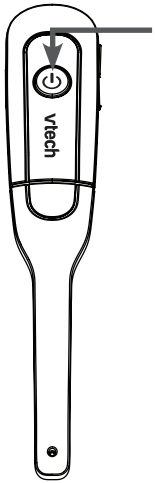

⏻ (on/off)

- Press and hold two seconds to power on or off.
- Press to answer, end or join a call (pages 36 and 43).
- On in red when charging in the telephone base.
- On in blue when fully charged in the telephone base.
- Flashes once every 10 seconds in blue when in idle mode.
- Flashes once every 10 seconds in red when in low battery mode.
- Flashes twice every three seconds in blue while on a call.
- Flashes quickly in blue while being paged.
- Flashes quickly and alternately in red and blue while being registered.
- Flashes four times every four seconds in blue when there is an incoming call.

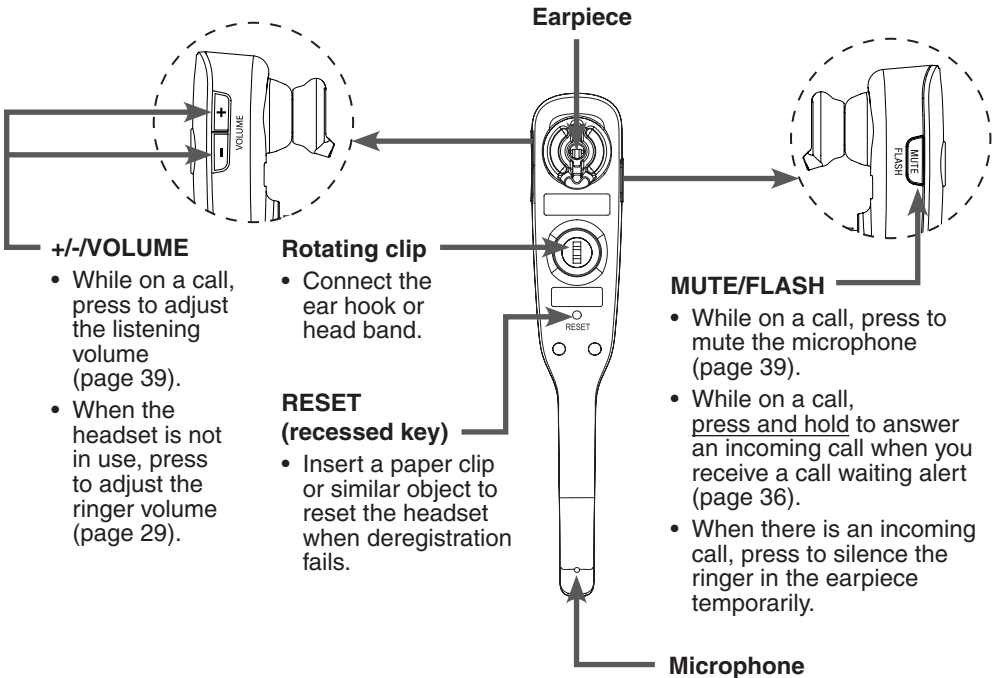

+/-VOLUME

- While on a call, press to adjust the listening volume (page 39).
- When the headset is not in use, press to adjust the ringer volume (page 29).

Rotating clip

- Connect the ear hook or head band.

RESET (recessed key)

- Insert a paper clip or similar object to reset the headset when deregistration fails.

MUTE/FLASH

- While on a call, press to mute the microphone (page 39).
- While on a call, press and hold to answer an incoming call when you receive a call waiting alert (page 36).
- When there is an incoming call, press to silence the ringer in the earpiece temporarily.

Bluetooth

Introducing Bluetooth

Your new **DS6671/DS6672/DS667V** telephone system with Bluetooth wireless technology has the following features:

- Pair and connect up to a maximum of two cell phones with the telephone base to make and receive cell calls. Both cell phones can be active on a call at a time.
- Make and receive calls using your cell phone plan while utilizing the ease and comfort of your home telephone system.
- Receive phonebook entries from your cell phone.

IMPORTANT INFORMATION

- Refer to the user's manual of your Bluetooth enabled cell phone for more information about how that device uses Bluetooth connectivity.
- Bluetooth wireless technology operates within a short range (a maximum of approximately 30 feet) from the telephone base. Keep connected cell phones within this range. For optimal performance, keep your cell phone within 15 feet of the telephone base while using the **DS6671/DS6672/DS667V** cell line.
- If your cell phone has poor reception in your home, the **DS6671/DS6672/DS667V** cannot improve the reception. However, if there is a location in your house with better reception, you can leave your cell phone at that location while you use the **DS6671/DS6672/DS667V** cell line.
- If you experience poor sound quality, your cell phone may be too far away from the telephone base. To improve Bluetooth signal strength, place your cell phone closer to the telephone base (within 15 feet) and make sure that there are no physical obstacles between the telephone base and the cell phone, such as large furniture or thick walls.

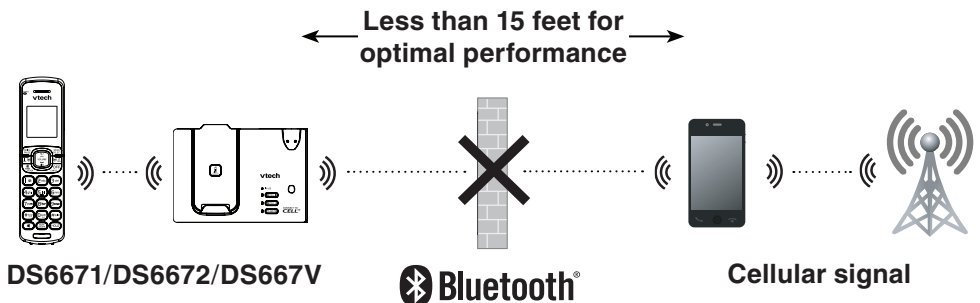

Bluetooth

IMPORTANT INFORMATION

- Charge your cell phone while it is connected to the telephone base. Your cell phone's battery will discharge faster while it is connected to the telephone base via Bluetooth wireless technology.
- Monitor your cell phone's usage because minutes are deducted from your cellular plan for the duration of all cell calls, depending on the terms of your plan.

Refer to **Bluetooth setup** (page 24) to learn how to set up and manage your Bluetooth enabled devices. Refer to **Telephone operation** (page 36) on how to operate your Bluetooth devices with your new **DS6671/DS6672/DS667V** telephone system with Bluetooth wireless technology. Refer to **Troubleshooting** (page 84) if you experience difficulty using the telephone system.

The *Bluetooth*[®] word mark and logos are owned by Bluetooth SIG, Inc. and any use of such marks by VTech Holdings Limited is under license.



VTech Holdings Limited is a member of Bluetooth SIG, Inc. Other trademarks and trade names are those of their respective owners.



Bluetooth





Glossary of terms

Below are some terms used in this user's manual to help you become familiar with using your Bluetooth enabled cell phone and your new **DS6671/DS6672/DS667V** telephone system.

Bluetooth cell phone - refers to a Bluetooth enabled cellular telephone.

Cell line - the telephone line associated with your cell phone service. On your **DS6671/DS6672/DS667V** handset, press  **CELL 1** or  **CELL 2** to use the cell line.

Connected - when you pair a Bluetooth cell phone to the **DS6671/DS6672/DS667V**, it is automatically connected. When a cell phone is connected, **1** and/or **2** displays after  on the handset and the  **CELL 1** and/or  **CELL 2** light on the telephone base is on. If a cell phone loses its connection to the telephone base, it must be reconnected before you can use the cell phone with the **DS6671/DS6672/DS667V**.

Disconnected - when a cell phone is disconnected, the status icon () on the handset no longer displays and the  **CELL 1**/ **CELL 2** light on the telephone base is off.

Discoverable mode - before a Bluetooth enabled device can be paired, it must be set to this mode. When pairing your cell phone, the telephone base will be set to this mode. Depending on the manufacturer, this mode is sometimes referred to as **Find Me** or **Visibility**.

Home line - your conventional telephone land line. On your **DS6671/DS6672/DS667V** handset, press /**HOME** to use the home line.

Paired device - once a Bluetooth enabled cell phone has been paired with the telephone base, it appears on the cell devices list. A maximum of two cell phones can be paired with the telephone base.

Pairing - this refers to the process of Bluetooth enabled cell phone registering device information with each other. The telephone base must be paired with the Bluetooth enabled cell phone before it can be used. Depending on the manufacturer, this is also referred to as **Bonding**.

PIN - by default, the PIN is **0000** for the telephone base and for most Bluetooth devices. PIN information must be exchanged between Bluetooth devices before they can be used. This is also known as a **Passkey** or **Passcode**.

Bluetooth

Bluetooth setup

To use a Bluetooth enabled cell phone with your **DS6671/DS6672/DS667V**, you must first pair and connect it with the telephone base. The **DS6671/DS6672/DS667V** telephone base and all system handsets can be used to make or answer calls on the cell phone line.

Bluetooth wireless technology operates within a short range (a maximum of approximately 30 feet). When you pair a Bluetooth cell phone to the telephone base, make sure your Bluetooth cell phone is close to the telephone base to maintain sufficient signal strength. For optimal performance, keep your cell phone within 15 feet of the telephone base while using the cell line.

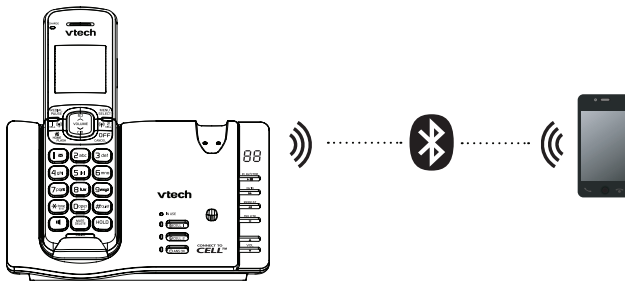

VTech Connect to Cell™ application

If you are using Bluetooth enabled Android® phones (OS 2.3 or higher), you can further extend the flexibility of your telephone system with use of this free application.

VTech Connect to Cell comprises **Caller ID manager** and **Alerts manager** that help you integrate your cell phone with your new **DS6671/DS6672/DS667V**.

To learn more or download this application via **Google Play® Store**, go to http://www.vtechphones.com/app_connect_to_cell.



Bluetooth

Add a cell phone

Before you begin, make sure that you have cellular coverage and your Bluetooth enabled cell phone is not connected to any other Bluetooth devices. Refer to the user's manual of your cell phone to learn how to search for or add new Bluetooth devices.

You can pair and connect up to two cell phones to the telephone base. All paired cell phones are shown on the cell device list. Both Bluetooth cell phones can be on a call at a time.

Once you have paired and connected a device with the telephone base, you do not need to repeat the procedure again unless you have replaced the paired cell phone with a new one.

To pair and connect a cell phone:

1. Press and hold **CELL 1/CELL 2** on the telephone base for about four seconds. You hear a tone and the **CELL 1/CELL 2** light blinks.
 - If there is already a cell phone in the slot, the existing cell phone will be erased from the cell device list.
2. Turn on the Bluetooth feature of your cell phone. Once your cell phone finds your VTech phone (**VTech DS6671/VTech DS6672/VTech DS667V**), press the appropriate key on your cell phone to continue the pairing process.

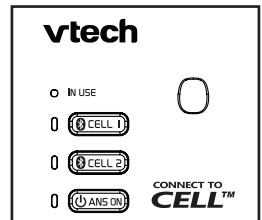

- Your cell phone may prompt you to enter the PIN of the telephone base. The default PIN of the telephone base is **0000**.
 - All cell phones that are connected to the telephone base are disconnected temporarily until the pairing process is completed.
3. When the cell phone is successfully paired and connected to the telephone base, you hear a tone. The corresponding status icon (**CELL 1/CELL 2**) displays on the handset and the corresponding device light (**CELL 1/CELL 2**) on the telephone base turns on.



If you have trouble pairing your cell phone, it may not be compatible with your DS6671/DS6672/DS667V. Check the Bluetooth compatibility list at www.vtechphones.com.

note

- The pairing process may take up to one minute. If the pairing process fails, try again.
- The steps for the pairing process may vary for different cell phones. If this happens, follow the prompts on your cell phone and your **DS6671/DS6672/DS667V** to complete the pairing process.

Bluetooth

Auto connection

A cell phone may be disconnected from the telephone base when:

- The Bluetooth feature of your connected cell phone is turned off.
- The power of your cell phone is turned off.
- Your cell phone is not within range of the telephone base.

When the Bluetooth feature or power on the cell phone is turned on, or it moves within range of the base, the base will try to reconnect to the cell phone.

Connect a paired cell phone

If you need to connect your paired cell phone to the telephone base manually:

1. Press **CELL 1/CELL 2** on the telephone base when it is not in use. The **CELL 1/CELL 2** light blinks.
2. When the cell phone is connected to the telephone base, you hear a tone. The corresponding status icon (**CELL 1/CELL 2**) displays on the handset. The corresponding device light (**CELL 1/CELL 2**) on the telephone base turns on.

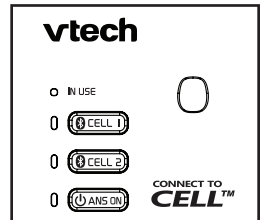

Disconnect a paired cell phone

If you need to disconnect a paired cell phone from the telephone base, refer to your cell phone user's manual for instructions to disconnect a Bluetooth device.

If you press and hold **CELL 1/CELL 2** on the telephone base, the existing paired cell phone in that slot will be erased. See **Add a cell phone** (page 25) on how to pair and connect a new cell phone.

Cell ringer (Ringtone Share)

The cell ringer (ringtone share) feature allows you to set your telephone to play your iPhone® ringer. When you pair an iPhone (with iOS4.1 or later) to your **DS6671/DS6672/DS667V**, the **DS6671/DS6672/DS667V** handsets play your iPhone's ringer when you receive a call on your iPhone.

1. Press **MENU** when the phone is not in use.
2. Press **▼** or **▲** to scroll to **Bluetooth**, then press **SELECT**.
3. Press **▼** or **▲** to scroll to **Cell ringer**, then press **SELECT**.
4. Press **▼** or **▲** to scroll to **On** or **Off**, then press **SELECT**.

iPhone® is a registered trademark of Apple Inc.

Bluetooth

Download phonebook

You can download two cell phonebooks (up to 1000 entries each) to your **DS6671/DS6672/DS667V** telephone system via Bluetooth wireless technology. Each downloaded phonebook is stored with up to 24 digits for each phone number and 15 characters for each name.

Before downloading the phonebook, make sure the cell phone is paired and connected to the **DS6671/DS6672/DS667V**. Make sure the handset battery is charged for at least 10 minutes.

Place your cell phone next to the telephone base while downloading.

To download a cell phone phonebook:

1. Press **MENU** when the phone is not in use.
2. Press \vee or \wedge to scroll to **Bluetooth**, then press **SELECT**.
3. Press \vee or \wedge to scroll to **Download PB**, then press **SELECT**.
4. Press \vee or \wedge to scroll to a desired device, then press **SELECT**.

- If there is no cell phone paired to the system, the handset displays **Pair cell first** and then returns to the previous menu.
- If the selected device is not available, the handset displays **Connect first** and then returns to the previous menu.

During the download, the handset flashes **Downloading...**
All other idle system handsets display **Downloading...**

5. When the downloading process completes or when the memory is full, the handset displays **Entries added: XXX**.
Then the handset returns to the Bluetooth menu.

note

- Certain cell phones do not support SIM card download. If this is the case, try transferring the contacts from your SIM card to your cell phone memory first, then download from your cell phone memory. For more information on how to transfer contacts from your SIM card to your cell phone memory, see the user's manual of your cell phone.
- For certain cell phones, you may need to press a key on your cell phone to confirm the phonebook download.
- For Android cell phones, you may also download your cell phone phonebook to your **DS6671/DS6672/DS667V** via the VTech Contact Share application.
Go to http://www.vtechphones.com/app_contact_share for application download.

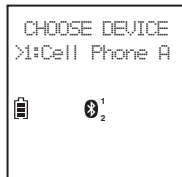
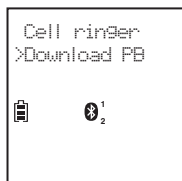

Telephone settings

Using the menu

You can use a cordless handset to change the telephone settings.

In the ringers menu, you can select the ringer tones and adjust the ringer volume for incoming calls.

In the settings menu, you can change the settings for LCD language, voicemail number, voicemail indicators, key tone, CID time synchronization and dial mode.

Go to **Answering system settings** (from page 64 to page 68) for instructions to change the answering system settings.

To enter the handset menu:

1. Press **MENU** when the phone is not in use.
2. Press **∨** or **∧** until the screen displays the desired feature menu.
3. Press **SELECT** to enter that menu.
 - To return to the previous menu, press **CANCEL**.
 - To return to idle mode, press and hold **CANCEL**.

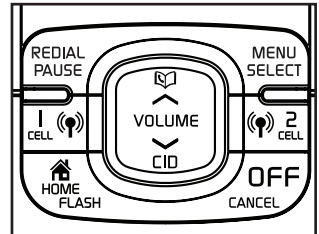

Telephone settings

Handset ringer volume

You can set the ringer volume or turn the ringer off on each handset. When the ringer is off,  appears on the screen.

1. Press **MENU** when the handset is not in use.
2. Press \vee or \wedge to scroll to **Ringers**, then press **SELECT**.
3. Press **SELECT** again to select **Ringer volume**.
4. Press \vee or \wedge to sample each volume level.
5. Press **SELECT** to save your selection and return to the previous menu. You hear a confirmation tone.

note The ringer volume also determines the ringer volume for intercom calls. If the ringer volume is set to off, that handset is silenced for all incoming calls except paging tone.

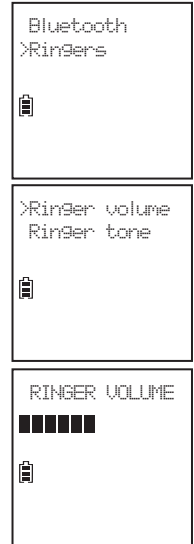

Telephone base ringer volume

Press \blacktriangledown /VOL or \blacktriangle /VOL on the telephone base to adjust the ringer volume when the telephone is not in use.

When you set the base ringer volume to off, the message window displays **0** and the system announces, “Base ringer is off.”

When the telephone is ringing, press \blacktriangledown /VOL to temporarily turn the base ringer off.

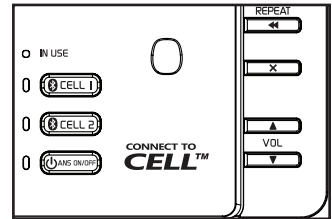

Headset ringer volume

The headset does not have an external ringer. When there is an incoming call, the headset earpiece rings.

To adjust the ringer volume:

Press \pm /VOLUME on the side of the headset when it is not in use.



Telephone settings

Ringer tone

You can choose from different ringer tones for each handset.

1. Press **MENU** when the handset is not in use.
2. Press \vee or \wedge to scroll to **Ringers**, then press **SELECT**.
3. Press \vee or \wedge to scroll to **Ringer tone**.
4. Press \vee or \wedge to scroll to **All lines**, **Home ringtone**, **Cell 1 tone** or **Cell 2 tone**, then press **SELECT**.
5. Press \vee or \wedge to sample each ringer tone.
6. Press **SELECT** to save your selection and return to the previous menu. You hear a confirmation tone.

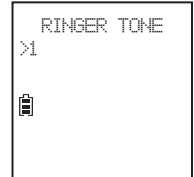

note

If you turn off the ringer volume, you will not hear ringer tone samples.



Quiet mode

You can turn on the quiet mode for a period of time (1-12 hours). During this period, all tones (except paging tone) and call screening are muted.

When you turn on the quiet mode, the answering system turns on automatically.

When the quiet mode duration expires, the answering system remains on.

To set the duration and turn on the quiet mode:

1. Press and hold **#quiet** when the handset is not in use.
2. The handset displays **Quiet: __ hours**. Use the dialing keys (**0-9**) to enter the duration (1-12 hours).
3. Press **SELECT** to confirm. You hear a confirmation tone. The handset displays **Answering sys is ON** briefly, then **Quiet mode on**, **ANS ON** and . The  **ANS ON** light on the telephone base turns on.



To turn off the quiet mode:

Press and hold **#quiet** to turn off the quiet mode. The handset displays **Quiet mode is off** briefly and then returns to idle.

note

If you change the settings of the ringer tone, handset ringer volume and telephone base ringer volume while the quiet mode is on, you can still hear the samples of them.



Telephone settings

Set date and time

The answering system announces the date and time of each message prior to playing it. Before using the answering system, set the date and time as follows. If you subscribe to caller ID service, the day, month and time are set automatically with each incoming call. However, the year must be correct so that the day of the week can be calculated from the caller ID information.

If you do not want to set the date and time automatically with caller ID information, turn off the CID time synchronization feature (see page 35).

To manually set the date and time:

1. Press **MENU** when the handset is not in use.
2. Press \vee or \wedge to scroll to **Set date/time**, then press **SELECT**.
3. Press \vee or \wedge to select the month then press **SELECT**, or use the dialing keys to enter a two-digit number (01-12).
4. Press \vee or \wedge to select the date then press **SELECT**, or use the dialing keys to enter a two-digit number (01-31).
5. Press \vee or \wedge to select the year then press **SELECT**, or use the dialing keys to enter a two-digit number (00-99) then press **SELECT**.
6. Press \vee or \wedge to select the hour then press **SELECT**, or use the dialing keys to enter a two-digit number (01-12).
7. Press \vee or \wedge to select the minute then press **SELECT**, or use the dialing keys to enter a two-digit number (00-59).
8. Press \vee or \wedge to scroll to **AM** or **PM**, or press **2** to choose **AM** or press **7** to choose **PM**.
9. Press **SELECT** to save the settings and return to the previous menu. You hear a confirmation tone.



```
Ringers
>Set date/time
```



```
SET DATE
MM/DD/YY
```



```
SET DATE
HH:MM --
```

note

- If the date and time are not set when a message is recorded, the system announces, *"Time and date not set,"* before each message plays.
- The telephone plays two beeps if you enter an invalid number.

Telephone settings

LCD language

You can select a language (**English**, **French** or **Spanish**) to be used in all screen displays.

1. Press **MENU** when the handset is not in use.
2. Press \vee or \wedge to scroll to **Settings**, then press **SELECT**.
3. Press **SELECT** to select **LCD language**.
4. Press \vee or \wedge to scroll to **English**, **Français** or **Español**, then press **SELECT**.
 - The screen displays **Set English as LCD language?** when you choose **English**.
 - The screen displays **Set Français as LCD language?** when you choose **Français**.
 - The screen displays **Set Español as LCD language?** when you choose **Español**.
5. Press **SELECT** to save your selection and return to the previous menu. You hear a confirmation tone.



note

If you accidentally changed the LCD language to French or Spanish, press **MENU**, then enter $\star_{\text{tone}} 364 \#_{\text{quiet}}$ to reset the LCD language to English.



Telephone settings

Voicemail number

If you subscribe to voicemail service offered by your telephone service provider, you can save the voicemail number to **1**  for easy access. When you want to retrieve voicemail messages, press and hold 1 . Contact your telephone service provider for more information and assistance about using your voicemail service.

To set the voicemail number:

1. Press and hold 1  when the phone is not in use.
2. Use the dialing keys to enter the voicemail number.
 - Press **DELETE** to erase a digit.
 - Press and hold DELETE to erase all digits.
 - Press \vee or \wedge to move the cursor to the left or to the right.
 - Press and hold PAUSE to insert a dialing pause (a **p** appears).
3. Press **SELECT** to save. The handset displays **Voicemail # saved** and then returns to idle mode.

-OR-

1. Press **MENU** when the handset is not in use.
2. Press \vee or \wedge to scroll to **Settings**, then press **SELECT**.
3. Press \vee or \wedge to scroll to **Voicemail #**, then press **SELECT**.
4. Use the dialing keys to enter the voicemail number.
 - Press **DELETE** to erase a digit.
 - Press and hold DELETE to erase all digits.
 - Press \vee or \wedge to move the cursor to the left or to the right.
 - Press and hold PAUSE to insert a dialing pause (a **p** appears).
5. Press **SELECT** to save. The handset displays **Voicemail # saved** and then returns to the previous menu. You hear a confirmation tone.

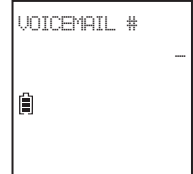
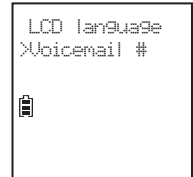

Telephone settings

Clear voicemail indicators

If you subscribe to voicemail service offered by your telephone service provider, **New voicemail** and  display on the handsets when you have new voicemail messages. Contact your telephone service provider for more information and assistance about using your voicemail service.

After you have listened to all new voicemail messages, the indicators on the handsets turn off automatically.

Use the clear voicemail feature when the telephone indicates that there is new voicemail but there are none (for example, when you have accessed your voicemail while away from home). Clearing the voicemail waiting indicators only turns off the indicators; it does not delete your voicemail messages. As long as you have new voicemail messages, your telephone service provider continues to send the signal to turn on the indicators.

To manually turn off the new voicemail indicators:

1. Press **MENU** when the handset is not in use.
2. Press \vee or \wedge to scroll to **Settings**, then press **SELECT**.
3. Press \vee or \wedge to scroll to **Clr voicemail**, then press **SELECT**.
The handset displays **Reset Voicemail Indicator?**

4. Press **SELECT** to confirm and return to the previous menu.
You hear a confirmation tone.

note

Your telephone service provider may alert you of new messages with a stutter (broken) dial tone. Contact your telephone service provider for details.

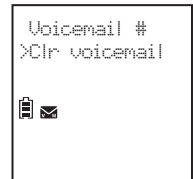

Key tone

You can set the key tone volume or turn it off for each handset. If you turn the key tone off, there are no beeps when you press the handset keys.

1. Press **MENU** when the handset is not in use.
2. Press \vee or \wedge to scroll to **Settings**, then press **SELECT**.
3. Press \vee or \wedge to scroll to **Key tone**, then press **SELECT**.
4. Press \vee or \wedge to select the desired volume or **Off**.
5. Press **SELECT** to save your selection and return to the previous menu. You hear a confirmation tone.

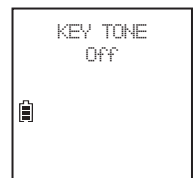
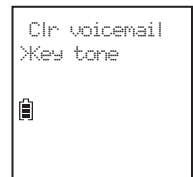

Telephone settings

CID time synchronization

This feature allows the time and date to be set by incoming caller ID information. The default setting is **On**.

1. Press **MENU** when the handset is not in use.
2. Press \vee or \wedge to scroll to **Settings**, then press **SELECT**.
3. Press \vee or \wedge to scroll to **CID time sync**, then press **SELECT**.
4. Press \vee or \wedge to choose **On** or **Off**.
5. Press **SELECT** to save your selection and return to the previous menu. You hear a confirmation tone.

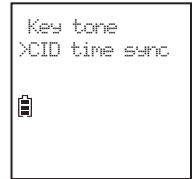

Dial mode

The dial mode is preset to touch-tone dialing. If you have pulse (rotary) service, you must change the dial mode to pulse dialing before using the telephone to make a call.

1. Press **MENU** when the handset is not in use.
2. Press \vee or \wedge to scroll to **Settings**, then press **SELECT**.
3. Press \vee or \wedge to scroll to **Dial mode**, then press **SELECT**.
4. Press \vee or \wedge to choose **Touch-tone** or **Pulse**.
5. Press **SELECT** to save your selection. Then the handset returns to the previous menu. You hear a confirmation tone.

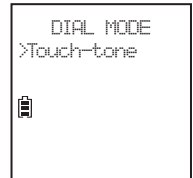

Telephone operation

Make a home call

1. Press **HOME** or **[MUTE]** on the handset.
2. When you hear a dial tone, dial the number.
3. Press **[CALL]** on the headset to join the call. Hang up the handset at any time to leave the call and the headset continues the call.

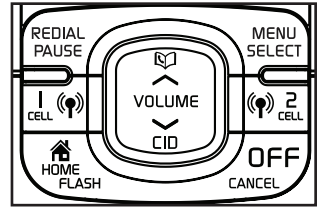

Predial a home call

1. Enter the telephone number.
2. Press **HOME** or **[MUTE]** to dial.
3. Press **[CALL]** on the headset to join the call. Hang up the handset at any time to leave the call and the headset continues the call.

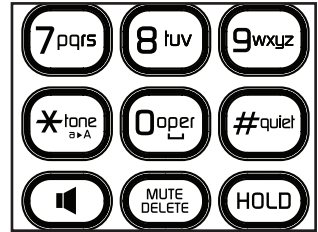

note

- The handset shows the elapsed time as you talk (in hours, minutes and seconds).
- While entering numbers, press **DELETE** to make corrections; press and hold PAUSE to insert a dialing pause (a **p** appears).
- If you make a predial call while the telephone line is in use, the screen displays **Unable to call. Line in use.**

Answer a home call

- Press **HOME**, **[MUTE]** or any dialing key (**0-9** or *** (tone)**) to answer.
- Press **[CALL]** on the headset.

End a home call

- Press **OFF** on the handset, or place the handset in the telephone base or handset charger.
- Press **[CALL]** on the headset or place the handset in the telephone base.

Call waiting on the home line

When you subscribe to call waiting service with your telephone service provider, the handset flashes **HOME** and you hear a beep if someone calls while you are already on a call.

- Press **FLASH** on the handset or press and hold FLASH on the headset to put your current call on hold and take the new call.
- Press **FLASH** on the handset or press and hold FLASH on the headset at any time to switch back and forth between calls.

Telephone operation

Make a cell call

1. Press **CELL 1** or **CELL 2**.

- The handset displays **Unable to call. Line in use** if your cell phone is in use.

2. Enter the telephone number, then press the corresponding **CELL** key to dial.

3. Press **CALL** on the headset to join the call. Hang up the handset at any time to leave the call and the headset continues the call.

-OR-

1. Enter the telephone number, then press **CELL 1** or **CELL 2**.

- The handset displays **Unable to call. Line in use** if your cell phone is in use.

2. Press **CALL** on the headset to join the call. Hang up the handset at any time to leave the call and the headset continues the call.

note

- The handset shows the elapsed time as you talk (in hours, minutes and seconds).
- While entering numbers, press **DELETE** to backspace and delete a digit; press and hold **REDIAL/PAUSE** to insert a dialing pause (a **p** appears).
- While using the cell line, place your cell phone closer to the telephone base, and make sure that there are no physical obstacles such as large furniture or thick walls between the telephone base and the cell phone.

Answer a cell call

• Press **HOME**, **CELL1**, **CELL 2**, **CALL** or any dialing key (**0-9** or ***tone**) to answer.

• Press **CALL** on the headset.

note

You can also use your cell phone to answer the call. If you answer with your cell phone, it will disconnect from the telephone base.

End a cell call



• Press **OFF** on the handset or place the handset in the telephone base or handset charger.

• Press **CALL** on the headset or place the headset in the telephone base.

Telephone operation

Call waiting on the cell line

When you subscribe to call waiting service with your cell phone service provider, the handset flashes  and you hear a beep if someone calls while you are already on a call.

- Press  **CELL 1** or  **CELL 2** on the handset or press and hold **FLASH** on the headset to put your current call on hold and take the new call.
- Press the corresponding  **CELL** key on the handset or press and hold **FLASH** on the headset at any time to switch back and forth between calls.

Answer a cell call while on a home call

While you are on a home call and you receive an incoming cell call, you hear a beep, and your handset flashes . The telephone base and all other handsets ring.

To answer the incoming cell call:

- Press  **CELL 1** or  **CELL 2** on the handset. The home line is put on hold.

To resume the home call on hold:

- Press  **/HOME** on the handset.

Cell phone voicemail

If you have voicemail service active on your cell phone, and you do not answer the incoming cell call, the call will be answered by your cell phone's voicemail. Contact your cell phone service provider for more information about voicemail service.

Answer a home call while on a cell call

While you are on a cell call and you receive an incoming home call, you hear a beep, and your handset flashes . The telephone base and all other handsets ring.



To answer the incoming home call:

- Press  **/HOME** on the handset. The cell line is put on hold.

To resume the cell call on hold:

- Press  **CELL 1** or  **CELL 2** on the handset.

Handset speakerphone

When the handset is on a call, press  to switch between the speakerphone and the handset earpiece. When the speakerphone is active, the  light turns on.

Telephone operation

Volume control

On a handset:

- During a call, press **VOLUME**/ or **VOLUME**/ to adjust the listening volume.

On a headset:

- During a call, press **+/-/VOLUME** on the side of the headset to adjust the listening volume. You hear an in-ear beep while adjusting. If you turn off the key tone, the in-ear beep will not be heard.

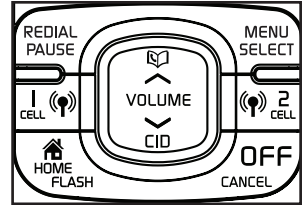

note

- The handset earpiece, headset earpiece and speakerphone volume settings are independent.
- When the volume reaches the minimum or maximum setting, you hear two beeps.

Mute

The mute function allows you to hear the other party but the other party cannot hear you.

On a handset:

- During a call, press **MUTE**. The handset displays **Muted** until the mute function is turned off.
- Press **MUTE** again to resume the conversation. The handset displays **Microphone ON** briefly.

On a headset:

- During a call, press **MUTE**. The headset announces, "Mute on." The headset beeps every 30 seconds until the mute function is turned off.
- Press **MUTE** again to resume the conversation. The headset announces, "Mute off."

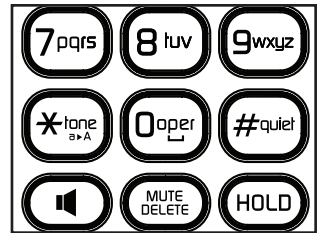

Hold

You can place a home or cell call on hold. You will hear an alert tone if you have not taken the call off of hold after 14 minutes. You will hear another alert tone 30 seconds later. At 15 minutes on hold, the call on hold automatically disconnects.

To place a home call on hold:

- Press **HOLD**. The handset displays **Home on hold** and /HOME/FLASH flashes.

To resume a home call on hold:

- Press /HOME/FLASH.

To place a cell call on hold:

- Press **HOLD**. The handset displays **Cell X on hold** and the CELL 1 or CELL 2 key flashes.

To resume a cell call on hold:

- Press the corresponding CELL key.

Telephone operation

Redial

Each handset stores the last 10 telephone numbers dialed (up to 30 digits).

When there are already 10 entries, the oldest entry is deleted to make room for the new entry.

To review and dial a redial number:

1. Press **REDIAL** to enter the redial list.
2. Press \downarrow , \uparrow or **REDIAL** repeatedly to browse until the desired entry displays.
3. Press HOME or M to dial using the home line.

-OR-

Press CELL 1 or CELL 2 to dial using the cell line.

-OR-

1. Press HOME or M to use the home line.

-OR-

Press CELL 1 or CELL 2 to use the cell line.

2. Press **REDIAL** to enter the redial list.
3. Press \downarrow , \uparrow or **REDIAL** repeatedly to browse until the desired entry displays.
4. If you use the home line, press **SELECT** to dial the displayed number.

-OR-

If you use the cell line, press the corresponding CELL key to dial.



To delete a redial entry

1. Press **REDIAL** to enter the redial list.
2. Press \downarrow , \uparrow or **REDIAL** repeatedly to browse to the desired entry.
3. Press **DELETE** to delete the displayed entry. You hear a confirmation tone.

Website

Use this feature to view the VTech website address.

1. Press **MENU** when the handset is not in use.
2. Press \downarrow or \uparrow to scroll to **Web address**, then press **SELECT**.

The handset displays the website address.



Telephone operation

Temporary ringer silencing

When the telephone is ringing, you can temporarily silence the ringer of the handset, headset or telephone base without disconnecting the call. The next call rings normally at the preset volume.

To silence the handset ringer:

- Press **OFF**, **MUTE** or **#quiet** on the handset and it displays **Ringer muted** and .

To silence the headset ringer:

- Press **MUTE** on the handset.

To silence the telephone base ringer:

- Press **▼/VOL** on the telephone base.



note

Each handset, the headset and the base ring when there is an incoming call unless the ringer volume of that device is turned off.

Chain dialing

Use this feature to initiate a dialing sequence from numbers stored in the phonebook, caller ID log or redial list while you are on a call.

Chain dialing can be useful if you wish to access other numbers (such as bank account numbers or access codes) from the phonebook, caller ID log or redial list.

To access a number from the phonebook while on a call:

1. Press **MENU**.
2. Press **▼** or **▲** to scroll to **Phonebook**, then press **SELECT**.
3. Press **▼** or **▲** to scroll to the desired phonebook, then press **SELECT**.
4. Press **▼** or **▲** to scroll to the desired entry.
5. Press **SELECT** to dial the displayed number.

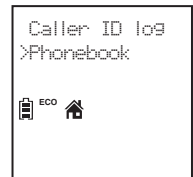

To access a number from the caller ID log while on a call:

1. Press **MENU**.
2. Press **▼** or **▲** to scroll to **Caller ID log**, then press **SELECT**.
3. Press **▼** or **▲** to scroll to the desired entry.
4. Press **SELECT** to dial the displayed number.



To access a number from the redial list while on a call:

1. Press **REDIAL** to enter the redial list.
2. Press **▼**, **▲** or **REDIAL** repeatedly to browse to the desired entry.
3. Press **SELECT** to dial the displayed number.



note

Press **CANCEL** to exit the phonebook, caller ID log or redial list when you are on a call.

Telephone operation

Temporary tone dialing

If you have pulse (rotary) service only, you can switch from pulse to touch-tone dialing temporarily during a call. This is useful if you need to send touch-tone signals to access your telephone banking or long distance services.

1. During a call, press ***tone**.
2. Use the dialing keys to enter the number you wish to dial. The telephone sends touch-tone signals. It automatically returns to pulse dialing mode after you end the call.

Find handset

This feature helps you find misplaced handsets and headset.

To start the paging tone:

- Press **FIND HANDSET** on the telephone base. All idle handsets and headsets ring and the handsets display **** Paging **** and the **Ⓛ** light on the headset flashes in blue.

To stop the paging tone:

- Press **Ⓜ/HOME**, **OFF**, **🔊**, **#quiet** or any dialing key (**0-9** or ***tone**) on a handset.

-OR-

- Press **Ⓛ** on the headset.

-OR-

- Press **FIND HANDSET** on the telephone base.

-OR-

- Place the handset in the telephone base or charger.

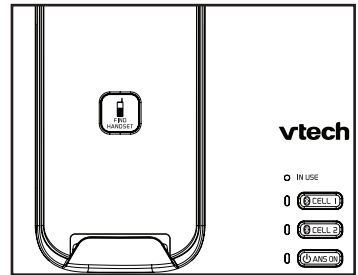

note

Press **MUTE** to turn off the ringer of a handset temporarily. Paging tone continues on all other handsets.

Check voicemail

- Press and hold **📧 1** on the handset to dial your stored voicemail number.

note







To set your voicemail number, see **Voicemail number** on page 33.

Multiple handset use

Join a call in progress

You can use four system handsets on an outside call at a time. You can buy additional expansion handsets (**DS6071/DS607V**) and an additional cordless headset (**IS6100**) for the telephone base. You can register up to 12 devices to the telephone base, including a maximum of two cordless headsets. The telephone base recognizes and counts a headset the same as a handset.

To join a call:

- When a handset is already on a call, you can join the call by pressing /HOME, CELL 1, CELL 2 or  on another handset, or  on the headset.
- To exit the call, press **OFF** or place the handset in the telephone base or charger, or press  on the headset or place the headset in the telephone base. The call will not end until all handsets and headsets hang up.

Multiple handset use

Intercom

Use the intercom feature for conversations between two system handsets, or a handset and a headset. Only one intercom call can be established at a time.

To initiate an intercom call:

1. Press **MENU** when the handset is not in use.
2. Press \vee or \wedge to scroll to **Intercom**, then press **SELECT**.
 - If you have one handset and one headset, your handset displays **Calling headset**.
 - If you have two handsets, your handset displays **Calling other handset**.
 - If you have three or more handsets and/or headsets, your handset displays **INTERCOM TO:** Press \vee or \wedge to scroll to the desired handset or headset then press **SELECT**, or enter a handset number (1-9 for **HANDSETS 1-9**, \star_{tone} and **0** for **HANDSET 10**, \star_{tone} and **1** for **HANDSET 11**, \star_{tone} and **2** for **HANDSET 12**, $\#_{\text{quiet}}$ and **1** for **HEADSET 1** or $\#_{\text{quiet}}$ and **2** for **HEADSET 2**).

The destination handset rings and its screen displays **Other handset is calling** or **HANDSET Y is calling**, or the destination headset earpiece rings and the 📞 light flashes in blue.

3. To answer the intercom call on the destination handset, press 🏠 /**HOME**, 📶 **CELL 1**, 📶 **CELL 2**, 🔇 or any dialing key (**0-9** or \star_{tone}). Both handsets now show **Intercom**.

-OR-

To answer the intercom call on the destination headset, press 📞 on the headset. The originating handset displays **Intercom**.

4. To end the intercom call on either handset, one party presses **OFF** or places the handset back in the telephone base or handset charger. Both handsets display **Intercom ended**.

-OR-

To end the intercom call on the destination headset, press 📞 or place the headset in the telephone base. The originating handset displays **Intercom ended**.





note

- You can cancel the intercom call before it is answered by pressing **OFF**.
- If the destination handset does not answer the intercom call within 100 seconds, or if it is out of range, on a call, or accessing the answering system, phonebook or caller ID log, your handset displays **No answer. Try again.** and then returns to idle mode.
- You can press **OFF**, **MUTE** or $\#_{\text{quiet}}$ on the destination handset to temporarily silence the intercom ringer.



Multiple handset use

Answer an incoming call during an intercom call

If you receive an incoming landline call during an intercom call, you will hear an alert tone. All handsets display  and the caller ID.

- To answer the call, press /**HOME**. The intercom call ends automatically.
- To end the intercom call without answering or canceling the incoming call, press **OFF**. The intercom call ends and the telephone continues to ring.

If you receive an incoming cell call during an intercom call, you will hear an alert tone. All handsets flash  and display the caller ID.

- To answer the call, press  **CELL 1** or  **CELL 2**. The intercom call ends automatically.
- To end the intercom call without answering or canceling the incoming call, press **OFF**. The intercom call ends and the telephone continues to ring.

Multiple handset use

Transfer a call using intercom

Use the intercom feature to transfer an outside call to another system handset or headset.

- When the handset is on a call, press **MENU**.
- Press \vee or \wedge to scroll to **Intercom**, then press **SELECT**. The outside call is put on hold automatically.
 - If you have one handset and one headset, your handset displays **Calling headset**.
 - If you have two handsets, your handset displays **Calling other handset**. The destination handset rings and displays **Other handset is calling**.
 - If you have three or more handsets and/or headsets, your handset displays **INTERCOM TO:** Press \vee or \wedge to scroll to the desired handset or headset then press **SELECT**, or enter a handset number (**1-9** for **HANDSETS 1-9**, \times_{tone} and **0** for **HANDSET 10**, \times_{tone} and **1** for **HANDSET 11**, \times_{tone} and **2** for **HANDSET 12**, $\#_{\text{quiet}}$ and **1** for **HEADSET 1** or $\#_{\text{quiet}}$ and **2** for **HEADSET 2**). Your handset displays **Calling HANDSET X** or **Calling HEADSET X**.
- To answer the intercom call:
 - Press HOME , **CELL 1**, **CELL 2**, MUTE or any dialing key (**0-9** or \times_{tone}) on the destination handset. Both handsets now display **Intercom**.
 - Press PHONE on the headset. The originating handset displays **Intercom**.
- From this intercom call, you have the following options:
 - To transfer the call, press **MENU** twice on the originating handset to choose **Transfer**. The originating handset displays **Transferred**. The destination handset or headset is automatically connected to the outside call.
 - To share the call, press **MENU** on your handset and then press \vee or \wedge to scroll to **Share call**. Then press **SELECT**. Both handsets are connected to the outside call.
- To end the outside call:
 - Press **OFF** or place the handset in the telephone base or charger.
 - Press PHONE or place the headset in the telephone base.



The call continues until all handsets hang up.

note

- You can cancel the intercom call before it is answered by pressing **CANCEL**.
- If the destination handset does not answer the intercom call within 100 seconds, or if it is accessing the answering system, is out of range, or has no power, the originating handset displays **No answer. Try again.** and returns to the outside call.

Multiple handset use

Push-to-talk (PTT)

You can directly broadcast messages from one handset to the speakerphone of one or multiple handsets. Press and hold **PUSH TO TALK** to begin two-way communication. If only one handset is available or registered, the handset shows **PTT requires two handsets** when you press **PUSH TO TALK**.

- Only one handset can talk at a time. To do so, press and hold **PUSH TO TALK** while you are talking.
- You must release **PUSH TO TALK**, so the other person can respond.
- Only one PTT session can be active at a time.
- While PTT is in use between two handsets, other handsets cannot use the intercom feature.
- If you attempt to place a PTT call to another handset that is on an outside call or intercom call, or accessing the answering system, your handset displays **Not available at this time**.

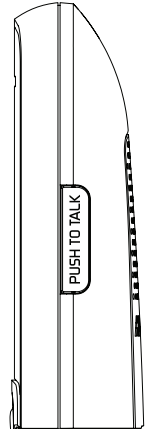

Turn PTT on or off

1. Press **PUSH TO TALK** when the handset is not in use. The **PUSH TO TALK** menu displays.
2. Press \vee or \wedge to scroll to **PTT On/Off**, then press **SELECT**.
3. Press \vee or \wedge to choose **On** or **Off**, then press **SELECT**.

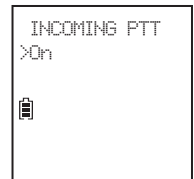

Multiple handset use

PTT to a single handset

1. You have two ways to begin a PTT call:

- If you have two handsets, press and hold **PUSH TO TALK** when the handset is not in use.
- If you have three or more handsets, press **PUSH TO TALK** when the handset is not in use. Press \vee or \wedge to scroll to the desired handset and then press **SELECT** or **PUSH TO TALK** to create the push-to-talk session, or enter a handset number (**1-9** for **HANDSETS 1-9**, \star tone and **0** for **HANDSET 10**, \star tone and **1** for **HANDSET 11**, \star tone and **2** for **HANDSET 12**).

Your handset displays **Connecting to HANDSET X...** for a few seconds. When the connection is made, both the originating and the destination handsets display **Press and hold [PTT] to talk** and beep once.

2. Press and hold **PUSH TO TALK** on your handset. A chirp indicates your microphone is on. Speak towards the handset. Your voice is broadcast to the destination handset. While you are speaking, your handset displays **PTT To handset: X**

3. Release **PUSH TO TALK** after speaking. Both handsets beep once again. After the handsets beep, you can press and hold **PUSH TO TALK** to continue speaking or the destination handset can respond (see **Answer a PTT call** on page 50).

4. Press **OFF** to end the PTT call. The handset displays **Push to talk Ended** for a few seconds.

-OR-

Place the handset in the telephone base or charger to end the PTT call.

note

- After **PUSH TO TALK** is released, the PTT call remains open for a short time. If no one presses **PUSH TO TALK** within 10 seconds, the PTT call ends automatically.
- If PTT is turned off in the destination handset, the originating handset displays **Not available at this time** and returns to idle mode.

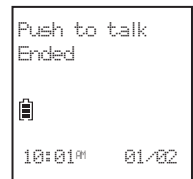
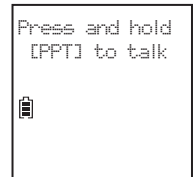

Multiple handset use

PTT to multiple handsets

When there are multiple handsets registered to the telephone system, PTT supports one-to-group calls. PTT supports a maximum of one-to-four calls when five handsets are registered, and a maximum of one-to-three calls when six or more handsets are registered. The first four registered handsets will be able to use this feature. Other handsets can only use PTT for one-to-one calls.

1. To begin a PTT call to multiple handsets:

- Press and hold **PUSH TO TALK** when the handset is not in use.
- If you have more than two handsets, press **PUSH TO TALK** when the handset is not in use. Press ***tone and #**, or **∨** or **∧** to scroll to **Group** then press **SELECT** or **PUSH TO TALK**.

Your handset displays **Connecting to group...** for a few seconds.

When the connection is made, all handsets display **Press and hold [PTT] to talk** and beep once.



2. Press and hold **PUSH TO TALK** on your handset. A chirp indicates your microphone is on. Speak towards the handset. Your voice is broadcast to all destination handsets.

While you are speaking, your handset displays **PTT To handset: ☒**.



3. Release **PUSH TO TALK** after speaking. All eligible handsets beep once again. After the handsets beep, you can press and hold **PUSH TO TALK** to speak again or the destination handsets can respond (see **Answer a PTT call** on page 50).
4. Press **OFF** to end the PTT call. The handset displays **Push to talk Ended** for a few seconds.

-OR-

Place the handset in the telephone base or charger to end the PTT call.

note

- After **PUSH TO TALK** is released, the PTT call session remains open for a short time. If no one presses **PUSH TO TALK** within 10 seconds, the PTT call session ends automatically.
- If PTT is turned off in all destination handsets, the originating handset displays **Not available at this time** and returns to idle mode.

Multiple handset use

Answer a PTT call

You can respond to a PTT call whenever the speakerphone light is off, as described below.

1. When your handset receives a PTT call, the handset beeps and the screen displays **Press and hold [PTT] to talk**.
2. When the other party is speaking, your speakerphone light is on, and your handset displays **PTT From HS X To HS Y** (a maximum of four handset numbers appear).
3. When your speakerphone light is off and the screen displays **Press and hold [PTT] to talk, press and hold PUSH TO TALK** on your handset. You will hear a chirp. Speak towards the handset.
 - While you are speaking, your handset displays **PTT To handset: Y** (a maximum of four handset numbers appear).
 - Your voice is broadcast to all destination handsets.

After speaking, release **PUSH TO TALK**. Your handset will beep. After the beep, if your speakerphone light is off, you can press and hold **PUSH TO TALK** to speak again or the destination handset can respond.

Change a one-to-one PTT call to an intercom call

You can convert a one-to-one PTT session to an intercom call.

1. When your handset displays **Press and hold [PTT] to talk**, press **MENU**. The screen displays **Intercom**.
2. Press **SELECT**.
 - If you have two handsets, your handset displays **Calling other handset**. The destination handset temporarily displays **Push to talk Ended** and then **Other handset is calling**.
 - If you have three or more handsets, your handset displays **Calling HANDSET Y**. The destination handset temporarily displays **Push to talk Ended** and then **HANDSET X is calling**.
3. On the destination handset, press **HOME**, **CELL 1**, **CELL 2**, or any dialing key (**0-9** or ***tone**) to answer the intercom call. Both handsets now display **Intercom**.
4. To end the intercom call, press **OFF** or place the handset in the telephone base or charger. Both screens display **Intercom ended**.



Multiple handset use

End a PTT call

- For a one-to-one PTT call, both the originating and destination handsets can end the PTT call.
- For a PTT call to multiple handsets, the originating handset can end the PTT call. If any one of the destination handsets leaves the PTT call, the call continues until all handsets hang up.

To end or leave a PTT call:

- Press **OFF** or place the handset in the telephone base or charger. The handset displays **Push to talk Ended**.

note

After **PUSH TO TALK** is released, the PTT call remains open for a short time. If no one presses **PUSH TO TALK** within 10 seconds, the PTT call ends automatically.

Answer an incoming call during a PTT call

When you receive an incoming outside call during PTT, there is an alert tone. The PTT screen and the caller ID information display alternately.

- During a one-to-one PTT call, press **🏠/HOME**, **📶CELL 1**, **📶CELL 2**, **🔊** or any dialing key (**0-9** or ***tone**) on the originating or destination handset. The PTT call ends automatically and the outside call is answered.
- During a PTT call to multiple handsets, press **🏠/HOME**, **📶CELL 1**, **📶CELL 2**, **🔊** or any dialing key (**0-9** or ***tone**) on the originating handset. The PTT call ends automatically and the outside call is answered.
- During a PTT call to multiple handsets, press **🏠/HOME**, **📶CELL 1**, **📶CELL 2**, **🔊** or any dialing key (**0-9** or ***tone**) on any one of the destination handsets and that handset answers the outside call. The PTT call continues for the rest of the PTT participants.
- To leave the PTT call without answering the incoming call, press **OFF**. The telephone continues to ring.

Make an outgoing call during a PTT call

- During a one-to-one PTT call, press **🏠/HOME**, **📶CELL 1** or **📶CELL 2** to get a dial tone. The PTT call ends automatically.
- During a PTT call to multiple handsets, press **🏠/HOME**, **📶CELL 1** or **📶CELL 2** on the originating handset. The PTT call ends automatically and you get a dial tone.
- During a PTT call to multiple handsets, press **🏠/HOME**, **📶CELL 1** or **📶CELL 2** on any one of the destination handsets and that handset gets a dial tone. The PTT call continues for the rest of the PTT participants.

Phonebook

About the phonebook

This phone has three phonebooks, one home phonebook and two downloaded cell phonebooks, which are shared by all system handsets. The home phonebook stores up to 200 contacts with up to 30 digits for each phone number and 15 characters for each name. Each downloaded phonebook stores up to 1,000 entries with up to 30 digits for each phone number and 15 characters for each name.

- Phonebook entries are shared by all system handsets. Any additions, deletions or edits made on one handset are reflected on all handsets.
- When you access the phonebook with no records, the screen displays **Phonebook empty**.
- When the phonebook is full and you try to save an entry, the screen displays **Phonebook full**.
- When you try to save a number already stored in the phonebook, the screen displays **Number already saved**.
- When reviewing a phonebook entry with a telephone number that exceeds 15 digits, <*> appears in front of the telephone number. Press ***>** to move towards the end of the telephone number or press **#<** to move towards the beginning of the telephone number.
- Only one handset can review the phonebook at a time. If a handset tries to enter the phonebook while another handset is already in it, **Not available at this time** appears.

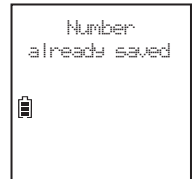
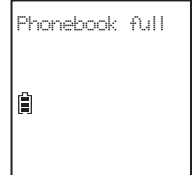
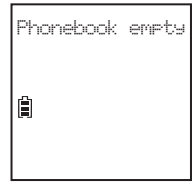

Phonebook

Add a phonebook entry to the home phonebook

1. Press **MENU** when the phone is not in use.
2. Press \vee or \wedge to scroll to **Phonebook**, then press **SELECT** twice.
3. Press \vee or \wedge to scroll to **Add contact**, then press **SELECT**.
4. When **ENTER NUMBER** displays, use the dialing keys to enter a number (up to 30 digits).
 - Press \vee or \wedge to move the cursor to the left or right.
 - Press **DELETE** to erase a digit.
 - Press and hold **DELETE** to erase all digits.
 - Press and hold **PAUSE** to enter a dialing pause (a **p** appears).

-OR-

Copy a number from the redial list by pressing **REDIAL**. Then press \vee , \wedge or **REDIAL** repeatedly to find the desired number. Press **SELECT** to copy the number.

5. Press **SELECT** to move on to the name.
6. When **ENTER NAME** displays, use the dialing keys to enter a name (up to 15 characters). Each time you press a key, the character on that key appears. Additional key presses produce other characters on that key. Press the key repeatedly until the desired character appears. The first character of every word is capitalized.
 - Press \vee or \wedge to move the cursor to the left or right.
 - Press **0** to add a space.
 - Press **DELETE** to erase a character.
 - Press and hold **DELETE** to erase all characters.
 - Press ***tone/a▶A** to switch the character between upper and lower case.

7. Press **SELECT** to save. The handset displays **Saved** and then returns to the previous menu. You hear a confirmation tone.

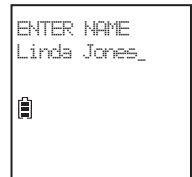
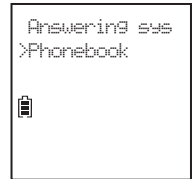

Phonebook

Add a phonebook entry to the home phonebook

-OR-

1. Use the dialing keys to enter a number (up to 30 digits) when the phone is not in use. Press **SELECT**. The handset displays **EDIT NUMBER**.
 - Press \vee or \wedge to move the cursor to the left or right.
 - Press **DELETE** to erase a digit.
 - Press and hold **DELETE** to erase all digits.
 - Press and hold **PAUSE** to enter a dialing pause (a **p** appears).

-OR-





Copy a number from the redial list by pressing **REDIAL**. Then press \vee , \wedge or **REDIAL** repeatedly to find the desired number. Press **SELECT** to copy the number.

2. Press **SELECT** to move on to the name.
3. When **ENTER NAME** displays, use the dialing keys to enter a name (up to 15 characters). Each time you press a key, the character on that key appears. Additional key presses produce other characters on that key. Press the key repeatedly until the desired character appears. The first character of every word is capitalized.
 - Press \vee or \wedge to move the cursor to the left or right.
 - Press **0** to add a space.
 - Press **DELETE** to erase a character.
 - Press and hold **DELETE** to erase all characters.
 - Press \star tone/a \blacktriangleright **A** to switch the character between upper and lower case.
4. Press **SELECT** to save. The handset displays **Saved** and then returns to the previous menu. You hear a confirmation tone.

Phonebook







Review phonebook entries

Phonebook entries appear alphabetically.



1. Press  when the phone is not in use.
2. Press  or  to scroll to the desirable phonebook, then press **SELECT** twice. The handset displays **Entries in PB XXX** briefly, then it displays the first entry in the phonebook.
3. Press  or  to browse through the phonebook.









-OR-

1. Press **MENU** when the phone is not in use.
2. Press  or  to scroll to **Phonebook**, then press **SELECT**.
3. Press  or  to scroll to the desirable phonebook, then press **SELECT**.
4. Press **SELECT** to choose **Review**.
5. The handset displays **Entries in PB XXX** briefly and then it displays the first phonebook entry. Press  or  to browse through the phonebook.

Alphabetical search

1. Press  when the phone is not in use.
2. Press  or  to scroll to the desirable phonebook, then press **SELECT** twice.

-OR-

- i. Press **MENU** when the phone is not in use.
 - ii. Press  or  to scroll to **Phonebook**, then press **SELECT**.
 - iii. Press  or  to scroll to the desirable phonebook, then press **SELECT**.
 - iv. Press **SELECT** to scroll to **Review**.
3. Use the dialing keys to enter the letter associated with the name. For example, if you have the entries named Jennifer, Jessie, Kevin and Linda in your phonebook, press **5** (JKL) once to see Jennifer (when Jennifer displays, press  to see Jessie), twice to see Kevin, or three times to see Linda. If there is no name entry matching your search, the next closest match in alphabetical order appears. If necessary, press  or  to browse.

Phonebook

Dial a phonebook entry

1. Search for the desired entry in the phonebook (see **Review phonebook entries** or **Alphabetical search** on page 55).
2. Press /HOME or to dial using the home line; or press CELL 1 or CELL 2 to dial using the cell line.

Edit a phonebook entry

1. Search for the desired entry in the phonebook (see **Review phonebook entries** or **Alphabetical search** on page 55).
2. When the desired entry displays, press **SELECT**. The handset displays **EDIT NUMBER**.
3. Use the dialing keys to edit the number.
 - Press or to move the cursor to the left or right.
 - Press **DELETE** to erase a digit.
 - Press and hold **DELETE** to erase all digits.
 - Press and hold **PAUSE** to enter a dialing pause (a **p** appears).
4. Press **SELECT**. The handset displays **EDIT NAME**.
5. Use the dialing keys to edit the name.
 - Press or to move the cursor to the left or right.
 - Press **DELETE** to erase a character.
 - Press and hold **DELETE** to erase all characters.
 - Press tone/a▶A to switch the character between upper and lower case.
6. Press **SELECT** to save the entry. The handset displays **Saved** and then the revised entry. You hear a confirmation tone.

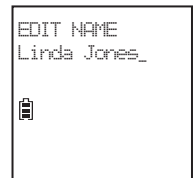

Phonebook

Delete a phonebook entry

1. Search for the desired entry in the phonebook (see **Review phonebook entries** or **Alphabetical search** on page 55).
2. Press **DELETE** and then the handset displays **Delete contact?**
3. Press **SELECT** to confirm. The handset displays **Contact deleted**. The handset returns to the previous menu and you hear a confirmation tone.

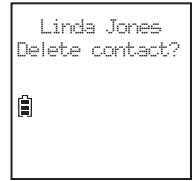

Remove an entire cell phonebook

1. Press **MENU** when the phone is not in use.
2. Press \vee or \wedge to scroll to **Phonebook**, then press **SELECT**.
3. Press \vee or \wedge to scroll to the desired cell phonebook, then press **SELECT**.
4. Press \vee or \wedge to scroll to **Remove PB**, then press **SELECT**.
5. When the handset displays **Remove PB?**, press **SELECT**. The handset displays **Deleting...** and you hear a confirmation tone. The handset returns to the previous menu.

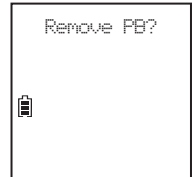
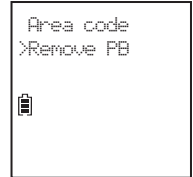

Caller ID

About caller ID

This product supports caller ID services offered by most telephone service providers. Depending on your service subscription, you may see the caller's number, or the caller's name and number that are sent by your telephone service provider after the first or second ring. Caller ID allows you to see the name, number, date and time of calls.

Information about caller ID with call waiting

Caller ID with call waiting lets you see the name and telephone number of the caller before answering the call, even while on another call.

It may be necessary to change your telephone service to use this feature. Contact your telephone service provider if:

- You have both caller ID and call waiting, but as separate services (you may need to combine these services).
- You have only caller ID service, or only call waiting service.
- You do not subscribe to caller ID or call waiting services.

There are fees for caller ID services. In addition, services may not be available in all areas.

This product can provide information only if both you and the caller are in areas offering caller ID service and if both telephone service providers use compatible equipment. The time and date, along with the call information, are from the telephone service provider.

Caller ID information may not be available for every incoming call. Callers may intentionally block their names and/or telephone numbers. To view caller ID log entries with numbers between 16 and 24 digits, you must save the entry to the phonebook (see page 62).

You can use this product with regular caller ID service, or you can use this product's other features without subscribing to caller ID or combined caller ID with call waiting service.

Caller ID

Caller ID log

If you subscribe to caller ID service provided by your telephone service provider and/or cell phone service provider, information about each caller will appear after the first or second ring. If you answer a call before the caller's information appears, it will not be saved in the caller ID log.

- The caller ID log stores up to 50 entries. Each entry has up to 24 digits for the phone number and 15 characters for the name. If the phone number has more than 15 digits, only the last 15 digits appear. If the name has more than 15 characters, only the first 15 characters are shown and saved in the caller ID log.
- Caller ID log entries are shared by all system handsets. Any modifications made on one handset apply to all.
- You can review, redial, and copy an entry into the phonebook.
- Entries appear in reverse chronological order.
- When the caller ID log is full, the oldest entry is deleted to make room for new incoming call information.
- **XX Missed calls** shows when there are new caller ID log entries that have not been reviewed.
- **Call ID log empty** shows when you access the caller ID log without records.
- Only one system handset can review the caller ID log at a time. If a handset tries to enter the caller ID log while another handset is already in it, its screen displays **Not available at this time**.

Memory match

If the incoming telephone number matches the last seven digits of a telephone number in your phonebook, the name that appears on the screen matches the corresponding name in your phonebook.

For example, if Mike Smith calls, his name appears as **Mike** if this is how you entered it into your phonebook.

note

The number shown in the caller ID log will be in the format sent by the telephone service provider. The telephone service provider usually delivers 10-digit phone numbers (area code plus telephone number). If the phone number of the caller does not match a number in your phonebook, the name will appear as it is delivered by the telephone service provider.

Caller ID

Missed call indicator

When there are calls that have not been reviewed in the caller ID log, the handsets display **XX Missed calls**. When you are reviewing a new caller ID log entry, 📞 displays to indicate that it is a landline call, or 📶 displays to indicate that it is a cell line call. When you have reviewed all the missed calls, the missed call indicator goes away.

Each time you review a caller ID log entry marked **NEW**, the number of missed calls decreases by one.

If you do not want to review the missed calls one by one, press and hold **CANCEL** on the handset when not in use to clear the missed call indicator. All the entries are then considered old and kept in the caller ID log.



Review the caller ID log

Review the caller ID log to find out who called, to return the call, or to copy the caller's name and number into your phonebook.

1. Press **CID** when the phone is not in use. The handset displays **Entries in CID XX** briefly.
2. Press \vee or \wedge to browse.

-OR-

1. Press **MENU** when the phone is not in use.
2. Press \vee or \wedge to scroll to **Caller ID log**, then press **SELECT**.
3. Press **SELECT** to choose **Review**.
4. Press \vee or \wedge to browse. You hear two beeps when you reach the beginning or end of the caller ID log.

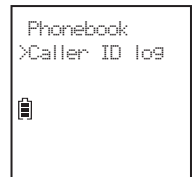
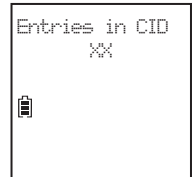

Caller ID

View dialing options

Although the caller ID log entries received have 10 digits (the area code plus the seven-digit number), in some areas, you may need to dial only the seven digits, or 1 plus the seven digits, or 1 plus the area code plus the seven digits. You can change the number of digits that you dial from the caller ID log and store the new number to the phonebook.

While reviewing the caller ID log, press **#**_{quiet} repeatedly to display different dialing options for local and long distance numbers before dialing or saving the telephone number in the phonebook.

Press **1** repeatedly if you need to add or remove 1 in front of the telephone number before dialing or saving it in the phonebook.

When the number is displayed in the correct format for dialing, press **HOME**, **CELL 1**, **CELL 2** or **CALL** to dial.

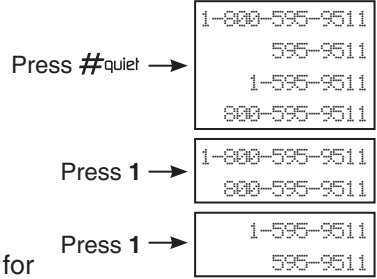

Caller ID

Dial a caller ID log entry

1. Search for the desired caller ID log entry (see **Review the caller ID log** on page 60).
2. When the desired entry displays, press **HOME**, **CELL 1**, **CELL 2** or **END CALL** to dial.

Save a caller ID log entry to the home phonebook

1. Search for the desired caller ID log entry (see **Review the caller ID log** on page 60).
2. When the desired entry displays, press **SELECT**. Then the handset displays **EDIT NUMBER**.
3. Use the dialing keys to edit the number, when necessary.
 - Press **LEFT** or **RIGHT** to move the cursor to the left or right.
 - Press **DELETE** to backspace and erase a digit.
 - Press and hold **DELETE** to erase the entire entry.
 - Press and hold **PAUSE** to insert a dialing pause (a **p** appears).
4. Press **SELECT** to move to the name. The handset displays **EDIT NAME**.
5. Use the dialing keys to add or edit the name.
 - Press **LEFT** or **RIGHT** to move the cursor to the left or right.
 - Press **DELETE** to erase a character.
 - Press and hold **DELETE** to erase all characters.
 - Press ***/tone/a▶A** to switch the character between upper and lower case.
 - Press **#quiet** to toggle the name order. For example, **Johnson Charlie** becomes **Charlie Johnson** when you press **#quiet**.
6. Press **SELECT** when done and the screen shows **Saved**.

note

If you save an entry which already exists in the phonebook, the handset displays **Number already saved** and then returns to previous screen.

Caller ID

Delete caller ID log entries

To delete one entry:

1. Search for the desired caller ID log entry (see **Review the caller ID log** on 60).
2. Press **DELETE** to delete the displayed entry.

To delete all entries:

1. Press **MENU** when the phone is not in use.
2. Press \vee or \wedge to scroll to **Caller ID log**, then press **SELECT**.
3. Press \vee or \wedge to scroll to **Del all calls**, then press **SELECT**.
4. When the screen shows **Delete all calls?**, press **SELECT** to confirm. You hear a confirmation tone.



Caller ID log screen messages

Displays:	When:
PRIVATE NAME	The caller is blocking the name.
PRIVATE NUMBER	The caller is blocking the telephone number.
PRIVATE CALLER	The caller is blocking the name and number.
UNKNOWN NAME	This caller's name is unavailable.
UNKNOWN NUMBER	This caller's number is unavailable.
UNKNOWN CALLER	No information is available about this caller.

Answering system settings

Answering system

Use the answering system menu of a cordless handset to turn on or off the answering system, message alert tone or call screening, set up the announcement message, or change the number of rings, remote access code or message recording time.

You may also turn on or off the answering system at the telephone base.



Announcement

The telephone is preset with a greeting that answers calls with, "Hello. Please leave a message after the tone." You can use this preset announcement, or replace it with your own.

Record your own announcement

You can record an announcement up to 90 seconds, but any announcement shorter than two seconds will not be recorded.

1. Press **MENU** when the phone is not in use.
2. Press \vee or \wedge to scroll to **Answering sys**, then press **SELECT** twice.
3. Press **SELECT** again to choose **Record annc**. The system announces, "Record after the tone. Press 5 when you are done."
4. After the tone, speak towards the microphone.
5. Press **5** when done. The answering system automatically plays back the newly recorded announcement, then returns to the previous menu.



Play your announcement

1. Press **MENU** when the phone is not in use.
2. Press \vee or \wedge to scroll to **Answering sys**, then press **SELECT** twice.
3. Press \vee or \wedge to scroll to **Play annc**, then press **SELECT** to play the current announcement.
 - Press **VOLUME**/ \vee or **VOLUME**/ \wedge to adjust the listening volume.
 - Press **5** to stop the announcement playback.
 - Press \blacksquare to switch between the speakerphone and the handset earpiece.



Answering system settings

Delete your announcement

1. Press **MENU** when the phone is not in use.
2. Press \vee or \wedge to scroll to **Answering sys**, then press **SELECT**.
3. Press **SELECT** again to choose **Announcement**.
4. Press \vee or \wedge to scroll to **Reset annnc**, then press **SELECT**. The handset displays **Reset to default annnc?**
5. Press **SELECT** to delete your recorded announcement. You hear a confirmation tone. The handset displays **Annnc. reset to default** and then the system announces, *“Announcement deleted.”*

note

When your announcement is deleted, calls are answered with the preset announcement.

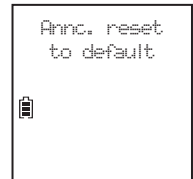
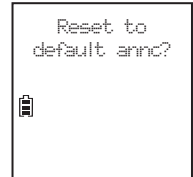

Answer on/off

The answering system must be turned on to answer and record messages. When the answering system is turned on, the ϕ **ANS ON** light on the telephone base turns on and **ANS ON** displays on the handset.

To turn on or off at the telephone base:

Press ϕ **ANS ON** to turn the answering system on or off.

If the answering system is turned on, the telephone base announces, *“Calls will be answered.”* If the answering system is turned off, the telephone base announces, *“Calls will not be answered.”*

To turn on or off with a handset:

1. Press **MENU** when the phone is not in use.
2. Press \vee or \wedge to scroll to **Answering sys**, then press **SELECT**.
3. Press \vee or \wedge to scroll to **Answer ON/OFF**, then press **SELECT**.
4. Press \vee or \wedge to scroll to **On** or **Off**, then press **SELECT** to confirm. You hear a confirmation tone.

note

- When you turn on the answering system at the telephone base with no memory capacity left, the answering system announces, *“Memory is full.”*
- If the remaining recording time is less than three minutes, the handset announces, *“Less than three minutes to record.”* and the handset displays **Rec mem low**.

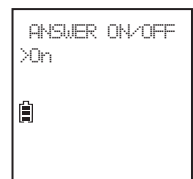
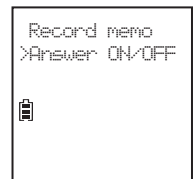
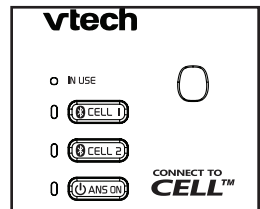

Answering system settings

Call screening

Use this feature to choose whether incoming messages can be heard while they are being recorded.

1. Press **MENU** when the phone is not in use.
2. Press \vee or \wedge to scroll to **Answering sys**, then press **SELECT**.
3. Press \vee or \wedge to scroll to **Ans sys setup**.
4. Press **SELECT** to choose **Call screening**.
5. Press \vee or \wedge to choose **On** or **Off**.
6. Press **SELECT** to save and you hear a confirmation tone.

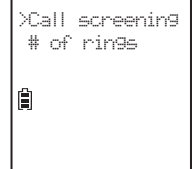
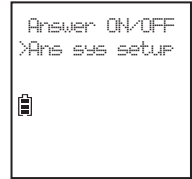

Number of rings

You can choose two, three, four, five or six rings; or toll saver. With toll saver selected, the answering system answers after two rings when you have new messages, or after four rings when you have no new messages. This enables you to check for new messages and avoid paying long distance charges when calling from out of your local area.

1. Press **MENU** when the phone is not in use.
2. Press \vee or \wedge to scroll to **Answering sys**, then press **SELECT**.
3. Press \vee or \wedge to scroll to **Ans sys setup**, then press **SELECT**.
4. Press \vee or \wedge to scroll to **# of rings**, then press **SELECT**.
5. Press \vee or \wedge to choose **6, 5, 4, 3, 2** or **Toll saver**.
6. Press **SELECT** to save and you hear a confirmation tone.



note

If you subscribe to voicemail service from your telephone service provider, see **Answering system and voicemail** on page 69.

Answering system settings

Remote access code

A two-digit security code is required to access the answering system remotely from any touch-tone telephone. The preset code is **19**. You can set the code from **00** to **99**.

1. Press **MENU** when the phone is not in use.
2. Press \vee or \wedge to scroll to **Answering sys**, then press **SELECT**.
3. Press \vee or \wedge to scroll to **Ans sys setup**, then press **SELECT**.
4. Press \vee or \wedge to scroll to **Remote code**, then press **SELECT**.
5. Use the dialing keys to enter a two-digit number, then press **SELECT** to save. You hear a confirmation tone.
 - Press **DELETE** to backspace and erase a digit.
 - Press and hold DELETE to erase the entire entry.
 - Press \vee or \wedge to move the cursor to the left or right.



```
# of rings
>Remote code
```



```
REMOTE CODE
19
```

Message alert tone

When the message alert tone is set to on, and there is at least one new message, the telephone base beeps every 10 seconds. The message alert tone is preset to off.

There is no audible alert at the handset.

1. Press **MENU** when the phone is not in use.
2. Press \vee or \wedge to scroll to **Answering sys**, then press **SELECT**.
3. Press \vee or \wedge to scroll to **Ans sys setup**, then press **SELECT**.
4. Press \vee or \wedge to scroll to **Msg alert tone**, then press **SELECT**.
5. Press \vee or \wedge to choose **On** or **Off**.
6. Press **SELECT** to save and you hear a confirmation tone.



```
Remote code
>Msg alert tone
```



```
MSG ALERT TONE
>Off
```

note

The answering system must be turned on for message alert tone to be functional.

Answering system settings

Recording time

You can set the recording time limit for each incoming message. The recording time is preset to three minutes.



1. Press **MENU** when the phone is not in use.
2. Press \vee or \wedge to scroll to **Answering sys**, then press **SELECT**.
3. Press \vee or \wedge to scroll to **Ans sys setup**, then press **SELECT**.
4. Press \vee or \wedge to scroll to **Recording time**, then press **SELECT**.
5. Press \vee or \wedge to choose **3 minutes**, **2 minutes** or **1 minute**.
6. Press **SELECT** to save and you hear a confirmation tone.



Answering system operation

Answering system and voicemail

Your telephone has separate indicators for two different types of voice messages: those left on its built-in digital answering system and those left with your telephone service provider's voicemail (fees may apply). Your telephone's built-in digital answering system messages and voicemail messages are separate. Each alerts you to new messages differently.

- If **XX New messages** displays on the handsets and the message window on the telephone base flashes, there are new messages in the built-in answering system. To listen to the messages recorded on your digital answering system, press ►/PLAY on the telephone base. To listen to messages with a handset, see **To play messages on a handset** on page 72.
- If  and **New voicemail** display on the handsets, your telephone service provider is indicating that it has new voicemail for you. To listen to your voicemail, press and hold **1**  on your handset. See **Voicemail number** on page 33 to set your voicemail number.



Some telephone service providers bundle or combine multiple services like voicemail and call waiting, so you may not be aware that you have voicemail. To check what services you have and how to access them, contact your telephone service provider.

To use your voicemail service rather than your answering system, turn off your answering system. To use your answering system rather than your voicemail service, contact your telephone service provider to deactivate your voicemail service.

Using the answering system and voicemail together

You can also use your telephone answering system and voicemail together by setting your built-in answering system to answer before voicemail answers as described below. To learn how to program your voicemail settings, contact your telephone service provider. Then, if you are on a call, or if the answering system is busy recording a message and you receive another call, the second caller can leave a voicemail message.

Set your answering system to answer calls at least two rings earlier than your voicemail is set to answer. For example, if your voicemail answers after six rings, set your answering system to answer after four rings. Some voicemail providers may program the delay before answering calls in seconds instead of rings. In this case, allow six seconds per ring when determining the appropriate setting.

Answering system operation

Message capacity

The answering system can record and store up to 99 messages. Each message can be up to three minutes in length, depending on the recording time set (see page 68). The total storage capacity for the announcement, messages and memos is approximately 14 minutes. The actual recording time depends on individual message characteristics. Messages remain available for replay until you delete them.

New message indication

The message window on the telephone base flashes and **XX New messages** displays on the handset when there are new answering system messages.

If the message alert tone is turned on, the telephone base beeps every 10 seconds when there are messages that have not been reviewed.



note

After reviewing new messages, the total number of messages appears on the message window.

Call screening

To screen a call at the telephone base:

If the answering system and call screening are turned on, the announcement and the incoming message broadcast at the telephone base while the call is answered by the answering system.

Options while a message is being recorded:

- Press ▼/VOL or ▲/VOL to adjust the call screening volume.
- Press ▲/VOL to temporarily turn on the call screening if the call screening is set to off.
- Press ►/■/PLAY/STOP to temporarily turn on or off the call screening.

To screen a call at a handset:



If the answering system is on, a call is answered by the answering system. At the same time, the handset shows **To screen call, press [SELECT]**. Press **SELECT** to screen the call on your handset. The handset shows the caller's information. If you do not subscribe to caller ID service, the handset shows **Screening...**

Options while a message is being recorded:



- Press VOLUME/⌵ or VOLUME/⌶ to adjust the listening volume.
- Press 🔊 to switch between the speakerphone and the handset earpiece.

Answering system operation

Call intercept

If you want to talk to the caller whose message is being recorded, press /HOME or  on the handset, or  on the headset.

Temporarily turn off the message alert tone

If the message alert tone is turned on (see page 67), the telephone base beeps every 10 seconds when there are new messages. Pressing any telephone base key (except  FIND HANDSET and  CELL 1/ CELL 2) temporarily silences the message alert tone.

If you press **X/DELETE** when in idle mode to temporarily turn off the message alert tone, there is a voice prompt directing you to press **X/DELETE** again to delete all old messages. The message alert tone is temporarily turned off. Only press **X/DELETE** a second time if you wish to erase all old messages in the answering system.

The message alert tone resumes when you receive a new message.

Answering system operation

Message playback

On the telephone base, when playback begins, the total number of old or new messages is announced, and the message window displays the message number currently playing.

On a handset, when playback begins, the total number of old or new messages is announced, and it displays the number of old and new messages.

Before each message, you hear the day and time of the recording. If the date and time are not set, you hear, "*Time and date not set,*" before playback.

After the last message, you hear, "*End of messages.*"

If the recording time is less than three minutes, you hear, "*Less than three minutes to record.*"

If there are no recorded messages, the handset shows **No messages** and you hear, "*You have no messages.*"

To play messages at the telephone base:

- Press ►/■/PLAY when the telephone base is not in use.

Options during playback:

- Press ▼/VOL or ▲/VOL to adjust the listening volume.
- Press ►/SKIP to skip to the next message.
- Press ◀/REPEAT to repeat the message. Press twice to hear the previous message.
- Press X/DELETE to delete the playing message.
- Press ►/■/STOP to stop the playback.

To play messages on a handset:

1. Press MENU when the phone is not in use.
2. Press SELECT to choose ↕Play messages.

Options during playback:

- Press VOLUME/⌋ or VOLUME/⌈ to adjust the listening volume.
- Press 6 to skip to the next message.
- Press 4 to repeat the message. Press 4 twice to hear the previous message.
- Press OFF to stop the playback.
- Press 📞 to switch between the speakerphone and the handset earpiece.

Answering system operation

Delete all old messages

You can only delete old (reviewed) messages. You cannot delete new messages until you review them. You cannot retrieve deleted messages.

To delete all old messages at the telephone base:

1. When the phone is not in use, press **X/DELETE**. The system announces, *"To delete all old messages, press **DELETE** again."*
2. Press **X/DELETE** again. The system announces, *"All old messages deleted."* You hear a confirmation tone.

To delete all old messages on a handset:

1. Press **MENU** when the phone is not in use.
2. Press \vee or \wedge to scroll to **Answering sys**, then press **SELECT**.
3. Press \vee or \wedge to scroll to **Delete all old**, then press **SELECT**. The handset shows **Delete all old messages?**
4. Press **SELECT** to confirm. The handset displays **Deleting...** then **All old msgs deleted!** and then returns to the previous menu. You hear a confirmation tone.

Record, play and delete memos

Memos are your own recorded messages used as reminders for yourself or others using the same answering system. You can record your own memos using a system handset. Play and delete them in the same way as incoming messages (see **Message playback** on page 72).

To record a memo:

1. Press **MENU** when the phone is not in use.
2. Press \vee or \wedge to scroll to **Answering sys**, then press **SELECT**.
3. Press \vee or \wedge to scroll to **Record memo**, then press **SELECT**.
4. The system announces, *"Record after the tone. Press 5 when you are done."* After the tone, speak towards the microphone.
5. Press **5** to stop recording. The system announces, *"Recorded."*

note

- *"Memory is full"* is announced if you record a memo when the memory is full.
- Each memo can be up to three minutes in length.
- Memos shorter than two seconds are not recorded.

Answering system operation

Remote access

A two-digit security code is required to access the answering system remotely from any touch-tone telephone. The preset code is **19**. See **Remote access code** on page 67 to change it.

1. Dial your telephone number from any touch-tone telephone.
2. When the system plays your announcement, enter the two-digit security code.
3. You can enter one of the following remote commands.

Command	Description
1	Play all messages.
2	Play new messages.
3	Delete the current message (during playback).
33	Delete all old messages.
4	Repeat the current message (during playback).
5	Stop.
*5	Hear a list of remote commands.
6	Skip to the next message (during playback).
*7	Record a new announcement.
8	End the call.
0	Turn the answering system on or off.

4. Hang up or press **8** to end the call.

note

- If you do not press any keys after you enter the remote access code, all new messages play. If there are no new messages, all old messages play.
- Once the new messages have played, the telephone announces the help menu options. If you do not press any key within 20 seconds, the remote access call automatically disconnects.
- When the answering system memory is full, the telephone announces, *"Memory is full. Enter the remote access code."*

Appendix

Expand your telephone system

You can add new handsets (**DS6071/DS607V**, purchased separately) and new headset (**IS6100**, purchased separately) to your telephone system. This telephone system accommodates up to 12 devices, including a maximum of two headsets.

For more details, refer to the user's manual that comes with your **DS6071/DS607V** new handset and **IS6100** new headset respectively.

Appendix

Message window displays

Window display	Description
0	No messages.
1-99	The total number of old messages and memos recorded. The message number currently playing.
0-99 (flashing)	The telephone base may have lost and regained power. The clock needs to be set.
1-99 & F (alternating)	The answering system memory is full with total number of messages recorded.
1-8	The telephone base speaker volume level while adjusting.
0-6	The telephone base ringer level while adjusting.
--- --	The answering system is answering a call, or recording a memo or announcement. The telephone is being accessed remotely. The answering system is being programmed.

Appendix

Screen messages

Calling HANDSET X	The handset is calling another handset (for intercom calls).
Caller ID log empty	There are no entries in caller ID log history.
Cell line busy	Another system handset is using the cell line.
Connect first	You need to connect the cell phone before making a cell call.
Contact deleted	A phonebook entry is deleted.
Downloading...	The telephone system is downloading the phonebook from a cell phone.
Ended	You have just ended a call.
Failed	The handset registration is not successful.
HANDSET X is calling	Another system handset is calling (for intercom calls).
Home	The handset is on a home call.
Home line busy	Another system handset is using the home line.
Incoming call	There is a call coming in.
Intercom	The handset is on an intercom call.
Intercom ended	The intercom call has just ended.
INTERCOM TO: (for models with two or more handsets)	You have started the intercom process, and need to enter the desired handset number.
Low battery	The handset battery needs to be recharged.
Microphone ON	The mute function is turned off and the other party can hear you.
Muted	The microphone is off. The other party cannot hear you.
New voicemail	There are new voicemail messages from your telephone service provider.
No battery	The handset in the telephone base or handset charger has no battery installed.
No home line	There is no telephone line connection.
Not available at this time	Someone else is using the phonebook, caller ID log or answering system.
Number already saved	The entry you try to save is already in the phonebook.
Out of range OR Base no power	The telephone base has lost power, or the handset is out of range.
Pair cell first	You need to pair a cell phone before making a cell call.

Appendix

Screen messages

Phonebook empty	There are no phonebook entries.
Phonebook full	The phonebook is full. You cannot save any new entries unless you delete some current entries.
Place in charger	The battery is very low. The handset should be charged.
Quiet mode is off	Quiet mode is turned off.
Quiet mode on	The telephone system is in quiet mode.
Rec mem full	The system recording time is full.
Rec mem low	The answering system has only three minutes of recording time left.
Registering...	The handset is registering to the telephone base.
Ringer off	The ringer is off temporarily during an incoming call.
Saved	The entry is saved in the phonebook.
To register HS, see manual.	Screen display on a non-registered handset.
Transferred	You have transferred an outside call to another handset.
Unable to call. Line in use	The handset is out of range while on a call. Failed phone call (the telephone line is in use). Failed intercom call (there are already two handsets being used).
XX Missed calls	There are new calls in the caller ID log.
XX New messages	There are new messages in the answering system.
** Paging **	The handset is paged by the telephone base.



Appendix

Handset and telephone base indicators

Handset lights

	On when the handset speakerphone is in use.
CHARGE	On when the handset is charging in the telephone base or handset charger.









Telephone base lights

IN USE	On when the telephone line is in use. On when the answering system is answering a call. On when you are registering a handset. Flashes quickly when there is an incoming call. Flashes when another telephone sharing the same line is in use. Flashes when you are deregistering all handsets.
 CELL 1/  CELL 2	On when a Bluetooth device is connected to the base. Blinks when the telephone base is in discoverable mode.
 ANS ON	On when the answering system is turned on.

Appendix

Handset and telephone base indicators

Handset icons

	The battery icon flashes when the battery is low and needs charging.
	The battery icon animates when the battery is charging.
	The battery icon becomes solid when the battery is fully charged.
ECO	The ECO mode activates automatically during calls to reduce power consumption.
	There are new voicemail received from your telephone service provider.
	On when the home line is in use or there is an incoming home call. Flashes when there is an incoming home waiting call.
 ¹ ₂	There are Bluetooth devices connected on the cell device list.
	On when the cell line is in use or there is an incoming cell call. Flashes when there is an incoming cell waiting call.
NEW	The caller ID log entry you are reviewing is new. The message you are listening is new.
ANS ON	The answering system is turned on.
	The handset ringer is off.
	The message number currently playing and total number of new/old messages recorded.

Appendix

Headset indicators

Headset alert tones

One beep	Headset key tone.
One beep every 30 seconds	Muted headset microphone alert tone.
Two quick beeps	Error alert tone. The volume reaches its minimum or maximum setting.
Two rapid beeps every 20 seconds	Low battery warning.
Three rapid beeps	The headset is being powered on or off.
Three rapid beeps every 20 seconds	Out of range while the headset is on a call. A non-registered headset with a charged battery.
Ringer tone	Incoming call alert tone.

Headset lights

Red	On when the headset is charging in the telephone base. Flashes once every 10 seconds to indicate the battery is low. Flashes three times when the headset is being powered off.
Blue	On when the headset is fully charged in the telephone base. Flashes once every 10 seconds when the charged headset is in idle mode. Flashes twice every three seconds when the headset is in use. Flashes three times when the headset is being powered on. Flashes quickly in blue while being paged. Flashes four times every four seconds when there is an incoming call.
Red and blue	Flashes quickly and alternately when the headset is trying to register to a telephone base. Flashes slowly and alternately when the headset is not registered.
Off	The headset battery is depleted. The headset has been powered off.

Appendix

Troubleshooting

If you have difficulty with your telephone, please try the suggestions below. For customer service, visit our website at www.vtechphones.com or call **1 (800) 595-9511**. In Canada, go to www.vtechcanada.com or dial **1 (800) 267-7377**.

I cannot add my cell phone to the telephone base.

- Make sure you have cellular coverage.
- Make sure your cell phone is compatible with your **DS6671/DS6672/DS667V**. Check the Bluetooth compatibility list at www.vtechphones.com.
- Make sure the Bluetooth function of your cell phone is turned on. See the user's manual of your cell phone for more information.
- Remove **VTech DS6671/DS6672/DS667V** from your cell phone's handsfree device history list (see the user's manual of your cell phone for more information).
- Carefully follow the pairing instructions on page 25 and make sure that your cell phone is not connected to any other Bluetooth device.
- Turn off your cell phone, then turn it on again.
- Reset the telephone base. Unplug the unit's electrical power. Wait for approximately 15 seconds, then plug it back in. Repeat the above suggestions.

I cannot connect my cell phone with the telephone base.

- Make sure that the Bluetooth function of your cell phone is turned on. See the user's manual of your cell phone for more information.
- Make sure that your Bluetooth cell phone is not connected to any other Bluetooth device.
- Turn off your cell phone, then turn it on again.
- Make sure that your cell phone is connected and active on the cell devices list.
- For some cell phones, you must authorize **VTech DS6671/DS6672/DS667V** device in your cell phone's Bluetooth feature. See the user's manual of your cell phone for more information.
- Manually connect your cell phone to **VTech DS6671/DS6672/DS667V**. Refer to the user's manual of your cell phone for more information.

I cannot find VTech DS6671/DS6672/DS667V on my cell phone.

- Make sure that the telephone base is in discoverable mode. Carefully follow the setup instructions on page 25.
- Make sure that you manually set your cell phone to search for devices.
- Remove **VTech DS6671/DS6672/DS667V** from your cell phone's handsfree device history list (see the user's manual of your cell phone).
- Turn off your cell phone, then turn it on again.
- Reset the telephone base. Unplug the unit's electrical power. Wait for approximately 15 seconds, then plug it back in. Repeat the above suggestions.

Appendix

Troubleshooting

I don't know how to search for or add new devices on my cell phone.

- Most cell phones have the Bluetooth feature in the connection or setup menus. Refer to the user's manual of your cell phone.
- In general, press the menu key on your cell phone, then look for the Bluetooth menu in the settings or connection menu. In the Bluetooth menu, select the option to search for or add new devices.

My cell phone disconnects from the telephone base.

- Turn off your cell phone, then turn it on again.
- Make sure that you are not using your cell phone when on a cell call.

My cell phone is connected to the telephone base, but I cannot make a cell call.

- Make sure that your cell phone is not in use when you are trying to make a cell call.
- For some smartphones, make sure that the cellular function is turned on.

The PIN on the telephone base does not work.

- Make sure you enter the correct PIN. The default PIN is **0000**.

I cannot hear any audio on my telephone system when on a cell call.

- Reset the telephone base. Unplug the unit's electrical power. Wait for approximately 15 seconds, then plug it back in.
- Turn off your cell phone, then turn it on again.

I cannot download contacts from my cell phone to the DS6671/DS6672/DS667V.

- Make sure that your cell phone is paired and connected to the base.
- Make sure you place your cell phone next to the base while downloading.

Can the DS6671/DS6672/DS667V help the poor cell phone reception in my house?

- If your cell phone has poor reception in your home, the **DS6671/DS6672/DS667V** cannot improve the reception. However, if there is a location in your house with better reception, you can leave your cell phone at that location while using the **DS6671/DS6672/DS667V** cell line. In order for this to work, the telephone base must be within 30 feet of the cell phone.

The listening volume of my cell call is too loud or quiet.

- During a cell call, if the listening volume is too loud or quiet, try changing the volume on your cell phone. On some cell phones, changing the volume on the cell phone affects your cell call volume on the **DS6671/DS6672/DS667V** handset.

Appendix

Troubleshooting

My telephone doesn't work at all.

- Make sure the power cord is securely plugged in.
- Make sure you plug the battery connector securely into the cordless handset.
- Make sure you plug the telephone line cord securely and firmly into the telephone base and the telephone wall jack.
- Unplug the electrical power to the telephone base. Wait for approximately 15 seconds, then plug it back in. Allow up to one minute for the cordless handset and telephone base to synchronize.
- Charge the battery in the cordless handset for at least 12 hours. For optimum daily performance, return the cordless handset to the handset charger when not in use.
- If the battery is completely depleted, charge the handset for at least 30 minutes before use (page 4).
- Reset the telephone base. Unplug the electrical power. Wait for approximately 15 seconds, then plug it back in. Allow up to one minute for the cordless handset and telephone base to reset.
- You may need to purchase a new battery. Refer to **Handset battery installation** (page 3) and **Handset battery charging** (page 4).
- Disconnect the telephone base from the telephone wall jack and plug in a working telephone. If the other telephone does not work, the problem is probably in the wiring or telephone service. Contact your telephone service provider.

The display shows No line. I cannot hear the dial tone.

- Disconnect the telephone line cord from your telephone and connect it to another telephone. If there is no dial tone on that other telephone either, then the telephone line cord may be defective. Try installing a new telephone line cord.
- If changing telephone line cord does not help, the wall jack (or the wiring to this wall jack) may be defective. Contact your telephone service provider.
- You may be using a new cable or VoIP service, the existing telephone jacks in your home may no longer work. Contact your service provider for solutions.

The display shows To register HS, see manual. The handset does not work at all.

- The handset is deregistered from the telephone base. Place the handset in the telephone base to register it back. The handset shows **HANDSET X Registered** and you hear a beep when the registration process completes. This process takes about 90 seconds to complete.

Appendix

Troubleshooting

The  light on the headset flashes slowly and alternately in red and blue. The headset does not work at all.

- The headset is deregistered from the telephone base. Follow the instructions below to register the headset back to the telephone base.
 1. **Press and hold  FIND HANDSET** on the telephone for about four seconds until the red **IN USE** light turns on.
 2. Immediately place the headset in the telephone base. The red **IN USE** light on the telephone base turns off.

The  light on the headset turns red when it is registered but not fully charged, or turns blue if it is registered and fully charged. This process takes about 60 seconds to complete.

I cannot dial out.

- Try all the suggestions above.
- Make sure you have a dial tone before dialing. The cordless handset may take a second or two to find the telephone base and produce a dial tone. This is normal. Wait an extra second before dialing.
- Eliminate any background noise. Noise from a television, radio or other appliances might cause the phone to not dial out properly. If you cannot eliminate the background noise, first try muting the cordless handset before dialing, or dialing from another room with less background noise.
- If other phones in your home are having the same problem, contact your telephone service provider (charges may apply).

My cordless handset isn't performing normally.

- Make sure you plug the power cord securely into the telephone base. Plug the power adapter into a different, working electrical outlet without a wall switch.
- Move the cordless handset closer to the telephone base. You may have moved out of range.
- Reset the telephone base. Unplug the electrical power. Wait for 15 seconds then plug it back in. Allow up to one minute for the cordless handset and telephone base to reset.
- Other electronic products such as HAM radios and other DECT phones can cause interference with your cordless phone. Try installing your phone as far away as possible from these types of electronic devices.

Appendix

Troubleshooting

Out of range OR Base no power appears on my cordless handset.

- Ensure you plug the telephone base in properly and the power is on.
- Place the cordless handset closer to the telephone base for synchronization.
- Move the cordless handset closer to the telephone base. You may have moved out of range.
- Reset the telephone base. Unplug the electrical power. Wait for 15 seconds then plug it back in. Allow up to one minute for the cordless handset and telephone base to reset.
- Other electronic products such as HAM radios and other DECT phones can cause interference with your cordless phone. Try installing your phone as far away as possible from these types of electronic devices.

The battery does not charge in the handset, or the handset battery does not accept charge.

- If the cordless handset is in the telephone base or handset charger and the charge light is not on, refer to **The charge light is off** (page 90).
- Charge the battery in the cordless handset for at least 12 hours. For optimum daily performance, return the cordless handset to the handset charger when not in use.
- If the battery is completely depleted, charge the handset for at least 30 minutes before use (page 4).
- You may need to purchase a new battery. Please refer to **Handset battery installation** (page 3) and **Handset battery charging** (page 4).

I get noise, static, or weak signals even when I'm near the telephone base.

- If you subscribe to high-speed Internet service (DSL - digital subscriber line) through your telephone line, you must install a DSL filter between the telephone line cord and the telephone wall jack (page 2). The filter prevents noise and caller ID problems as a result of DSL interference. Please contact your DSL service provider for more information about DSL filters.
- You may be able to improve the performance of your cordless phone by installing your new telephone base as far as possible from any other existing cordless telephone system that may already be installed.
- Other electronic products such as HAM radios and other DECT phones can cause interference with your cordless phone. Try installing your phone as far away as possible from these types of electronic devices.
- Do not install this phone near a microwave oven or on the same electrical outlet. You may experience decreased performance while the microwave oven is operating.
- If you plug your phone in with a modem or a surge protector, plug the phone (or modem/surge protector) into a different location. If this does not solve the problem, relocate your phone or modem farther apart from one another, or use a different surge protector.

Appendix

Troubleshooting

- Relocate your phone to a higher location. The phone may have better reception in a high area.
- If other phones in your home are having the same problem, contact your telephone service provider (charges may apply).

I experience poor sound quality when using the speakerphone.

- For increased sound quality while using the speakerphone, place the handset on a flat surface with the dialing keys facing up.

I hear other calls while using my phone.

- Disconnect the telephone base from the telephone jack, and plug in a different telephone. If you still hear other calls, contact your telephone service provider.

The telephone does not ring when there is an incoming call.

- Make sure that the ringer is not off. Refer to **Handset ringer volume** and **Telephone base ringer volume** on page 29 in this user's manual.
- Make sure you plug in the telephone line cord securely into the telephone base and the telephone jack. Make sure you plug in the power cord securely.
- The cordless handset may be too far from the telephone base.
- Charge the battery in the cordless handset for at least 12 hours. For optimum daily performance, return the cordless handset to the handset charger when not in use.
- You may have too many extension phones on your telephone line to allow all of them to ring simultaneously. Try unplugging some of the other phones.
- The layout of your home or office might be limiting the operating range. Try moving the telephone base to another location, preferably to a higher location.
- If other phones in your home are having the same problem, contact your telephone service provider (charges may apply).
- Test a working phone at the phone jack. If another phone has the same problem, contact your telephone service provider (charges may apply).
- Other electronic products such as HAM radios and other DECT phones can cause interference with your cordless phone. Try installing your phone as far away as possible from these types of electronic devices.
- Remove and install the battery again. Place the cordless handset in the telephone base or handset charger. Wait for the cordless handset to reestablish its connection with the telephone base. Allow up to one minute for this to take place.
- Your line cord may be defective. Try installing a new line cord.

Appendix

Troubleshooting

My calls cut in and out while I'm using my cordless handset.

- Other electronic products such as HAM radios and other DECT phones can cause interference with your cordless phone. Try installing your phone as far away as possible from these types of electronic devices.
- Do not install this phone near a microwave oven or on the same electrical outlet. You may experience decreased performance while the microwave oven is operating.
- If you plug your phone in with a modem or surge protector, plug the phone (or modem/surge protector) into a different location. If this does not solve the problem, relocate your phone or modem farther apart from one another, or use a different surge protector.
- Relocate your telephone base to a higher location. The phone may have better reception when installed in a high area.
- If other phones in your home are having the same problem, contact your telephone service provider (charges may apply).

The charge light is off.

- Make sure you plug the power and line cords in correctly and securely.
- Unplug the electrical power. Wait for 15 seconds, then plug it back in. Allow up to one minute for the cordless handset and telephone base to reset.
- Clean the charging contacts on the cordless handset, telephone base and handset charger each month with a pencil eraser or a dry non-abrasive cloth.

My caller ID isn't working properly.

- Caller ID is a subscription service. You must subscribe to this service from your telephone service provider for this feature to work on your phone.
- The caller must be calling from an area that supports caller ID.
- Both your and your caller's telephone service providers must use caller ID compatible equipment.
- If you subscribe to high-speed Internet service (DSL - digital subscriber line) through your telephone line, you must install a DSL filter between the telephone line cord and the telephone wall jack (page 2). The filter prevents noise and caller ID problems resulting from DSL interference. Please contact your DSL service provider for more information about DSL filters.

Appendix

Troubleshooting

My telephone does not receive caller ID when on a call.

- Make sure you subscribe to caller ID with call waiting features from your telephone service provider. Caller ID feature works only if both you and the caller are in areas offering caller ID service, and if both telephone service providers use compatible equipment.

The messages on the answering system are incomplete.

- If a caller leaves a very long message, part of it may be lost when the system disconnects the call after the preset message recording time.
- If the caller pauses for too long, the system stops recording and disconnects the call.
- If the system's memory becomes full during a message, the system stops recording and disconnects the call.
- If the caller's voice is very soft, the system may stop recording and disconnect the call.

The messages are very difficult to hear.

- Press **▲/VOL** on the telephone base or **VOLUME/∧** on the cordless handset to increase the listening volume.

The answering system does not answer after the correct number of rings.

- Make sure that the answering system is on. **ANS ON** should show on the handset and **⓪ ANS ON** light on the telephone base should be on.
- If toll saver is activated, the number of rings changes to two when you have new messages stored (page 66).
- If the memory is full or the system is off, the system will answer after 10 rings.
- In some cases, the answering system is affected by the ringing system used by your telephone service provider.
- If you subscribe to voicemail service, change the number of rings so that your answering system answers before your voicemail answers. To determine how many rings activate your voicemail, contact your telephone service provider.
- If there is a fax machine connected to the same telephone line, try disconnecting the fax machine. If that solves the problem, consult your fax machine documentation for information on compatibility with answering systems.

Appendix

Troubleshooting

The telephone does not respond to remote commands.

- Make sure you enter your remote access code correctly (page 74).
- Make sure you are calling from a touch-tone phone. When you dial a number, you should hear tones. If you hear clicks, the phone is not a touch-tone telephone and cannot activate the answering system.
- The answering system may not detect the remote access code while your announcement is playing. Try waiting until the announcement is over before entering the code.
- There may be interference on the phone line you are using. Press dialing keys firmly.

The answering system does not record messages.

- Make sure the answering system is on. **ANS ON** should show on the handset and **⓪ ANS ON** light on the telephone base should be on.
- Make sure the memory of the answering system is not full.
- If you subscribe to voicemail service, change the number of rings so that your answering system answers before your voicemail answers. To determine how many rings activate your voicemail, contact your telephone service provider.
- If there is a fax machine connected to the same telephone line, try disconnecting the fax machine. If that solves the problem, consult your fax machine documentation for information on compatibility with answering systems.

The system announces *“Time and day not set.”*

- You need to reset the system clock (page 31).

The outgoing announcement is not clear.

- When you record your announcement, make sure you speak in a normal tone of voice, about nine inches from the handset.
- Make sure there is no background noise (TV, music, etc.) while recording.

New voicemail and show and I don't know why.

- Your telephone has both a built-in answering system and voicemail indication. If **New voicemail** and  appear, then your telephone has received a signal from your telephone service provider that you have a voicemail message waiting for you to retrieve from them. Contact your telephone service provider for more information on how to access your voicemail.

Appendix

Troubleshooting

I cannot retrieve voicemail messages.

- Your telephone has both a built-in answering system and voicemail indication. They are independent features and each alerts you to new messages differently. If you subscribe to voicemail service from your telephone service provider, contact your telephone service provider for more information on how to access your voicemail.

I subscribe to a nontraditional telephone service that uses my computer to establish connections, and my telephone doesn't work.

- Make sure your computer is powered on.
- Make sure your Internet connection is working properly.
- Make sure that the software is installed and running for your nontraditional telephone service.
- Make sure to plug your USB telephone adapter into a dedicated USB port on your computer. Do not plug into a multiple port USB hub (USB splitter) that is not powered.
- In a few rare instances, the USB port on your computer may not have enough power. In these instances, try using a USB hub with its own external power supply.
- If you are using a firewall, it may prevent access to your nontraditional telephone service provider. Contact your service provider for more information.

I accidentally changed the LCD language to French or Spanish, and I don't know how to change it back to English.

- Press **MENU**, then enter ***^{tone}364#^{quiet}** to reset the LCD language to English.

Common cure for electronic equipment.

- If the telephone is not responding normally, do the following (in the order listed):
 1. Disconnect the power to the telephone base.
 2. Disconnect the cordless handset battery.
 3. Wait a few minutes.
 4. Connect power to the telephone base.
 5. Install the battery again, and place the cordless handset in the telephone base.
 6. Wait for the cordless handset to reestablish its connection with the telephone base. Allow up to one minute for this to take place.

Appendix

Important safety instructions

When using your telephone equipment, basic safety precautions should always be followed to reduce the risk of fire, electric shock and injury, including the following:

1. Read and understand all instructions.
2. Follow all warnings and instructions marked on the product.
3. Unplug this product from the wall outlet before cleaning. Do not use liquid or aerosol cleaners. Use a damp cloth for cleaning.
4. Do not use this product near water such as near a bath tub, wash bowl, kitchen sink, laundry tub or swimming pool, or in a wet basement or shower.
5. Do not place this product on an unstable table, shelf, stand or other unstable surfaces.
6. Avoid placing the telephone system in places with extreme temperature, direct sunlight, or other electrical devices. Protect your phone from moisture, dust, corrosive liquids and fumes.
7. Slots and openings in the back or bottom of the telephone base and handset are provided for ventilation. To protect them from overheating, these openings must not be blocked by placing the product on a soft surface such as a bed, sofa or rug. This product should never be placed near or over a radiator or heat register. This product should not be placed in any area where proper ventilation is not provided.
8. This product should be operated only from the type of power source indicated on the marking label. If you are not sure of the type of power supply in your home or office, consult your dealer or local power company.
9. Do not allow anything to rest on the power cord. Do not install this product where the cord may be walked on.
10. Never push objects of any kind into this product through the slots in the telephone base or handset because they may touch dangerous voltage points or create a short circuit. Never spill liquid of any kind on the product.
11. To reduce the risk of electric shock, do not disassemble this product, but take it to an authorized service facility. Opening or removing parts of the telephone base or handset other than specified access doors may expose you to dangerous voltages or other risks. Incorrect reassembling can cause electric shock when the product is subsequently used.
12. Do not overload wall outlets and extension cords.
13. Unplug this product from the wall outlet and refer servicing to an authorized service facility under the following conditions:
 - When the power supply cord or plug is damaged or frayed.
 - If liquid has been spilled onto the product.
 - If the product has been exposed to rain or water.
 - If the product does not operate normally by following the operating instructions. Adjust only those controls that are covered by the operation instructions. Improper adjustment of other controls may result in damage and often requires extensive work by an authorized technician to restore the product to normal operation.
 - If the product has been dropped and the telephone base and/or handset has been damaged.
 - If the product exhibits a distinct change in performance.
14. Avoid using a telephone (other than cordless) during an electrical storm. There is a remote risk of electric shock from lightning.
15. Do not use the telephone to report a gas leak in the vicinity of the leak. Under certain circumstances, a spark may be created when the adapter is plugged into the power outlet, or when the handset is replaced in its cradle. This is a common event associated with the closing of any electrical circuit. The user should not plug the phone into a power outlet, and should not put a charged handset into the cradle, if the phone is located in an environment containing concentrations of flammable or flame-supporting gases, unless there is adequate ventilation. A spark in such an environment could create a fire or explosion. Such environments might include: medical use of oxygen without adequate ventilation; industrial gases (cleaning solvents; gasoline vapors; etc.); a leak of natural gas; etc.
16. Only put the handset of your telephone next to your ear when it is in normal talk mode.

Appendix

Important safety instructions

17. The power adapters are intended to be correctly oriented in a vertical or floor mount position. The prongs are not designed to hold the plug in place if it is plugged into a ceiling, under-the-table or cabinet outlet.
18. For pluggable equipment, the socket-outlet shall be installed near the equipment and shall be easily accessible.

SAVE THESE INSTRUCTIONS

Battery

- CAUTION: Use Only Supplied Battery.
- Do not dispose of the battery in a fire. Check with local waste management codes for special disposal instructions.
- Do not open or mutilate the battery. Released electrolyte is corrosive and may cause burns or injury to the eyes or skin. The electrolyte may be toxic if swallowed.
- Exercise care in handling batteries in order not to create a short circuit with conductive materials.
- Charge the battery provided with this product only in accordance with the instructions and limitations specified in this manual.

Precautions for users of implanted cardiac pacemakers

Cardiac pacemakers (applies only to digital cordless telephones):

Wireless Technology Research, LLC (WTR), an independent research entity, led a multidisciplinary evaluation of the interference between portable wireless telephones and implanted cardiac pacemakers. Supported by the U.S. Food and Drug Administration, WTR recommends to physicians that:

Pacemaker patients

- Should keep wireless telephones at least six inches from the pacemaker.
- Should NOT place wireless telephones directly over the pacemaker, such as in a breast pocket, when it is turned ON.
- Should use the wireless telephone at the ear opposite the pacemaker.

WTR's evaluation did not identify any risk to bystanders with pacemakers from other persons using wireless telephones.

Operating range

This cordless telephone operates with the maximum power allowed by the Federal Communications Commission (FCC). Even so, this handset and telephone base can communicate over only a certain distance - which can vary with the locations of the telephone base and handset, the weather, and the layout of your home or office.

When the handset is out of range, the handset displays **Out of range OR Base no power**.

If there is a call while the handset is out of range, it may not ring, or if it does ring, the call may not connect well when you press /HOME. Move closer to the telephone base, then press /HOME to answer the call.

If the handset moves out of range during a telephone conversation, there may be interference. To improve reception, move closer to the telephone base.

ECO mode

This power conserving technology reduces power consumption for optimal battery performance. The ECO mode activates automatically during calls. When this mode is on, the handset displays **ECO**.

Appendix

Maintenance

Taking care of your telephone

Your telephone contains sophisticated electronic parts, so it must be treated with care.

Avoid rough treatment

Place the handset down gently. Save the original packing materials to protect your telephone if you ever need to ship it.

Avoid water

Your telephone can be damaged if it gets wet. Do not use the handset outdoors in the rain, or handle it with wet hands. Do not install the telephone base near a sink, bathtub or shower.

Electrical storms

Electrical storms can sometimes cause power surges harmful to electronic equipment. For your own safety, take caution when using electrical appliances during storms.

Cleaning your telephone

Your telephone has a durable plastic casing that should retain its luster for many years. Clean it only with a soft cloth slightly dampened with water or mild soap. Do not use excess water or cleaning solvents of any kind.

Remember that electrical appliances can cause serious injury if used when you are wet or standing in water. If the telephone base should fall into water, **DO NOT RETRIEVE IT UNTIL YOU UNPLUG THE POWER CORD AND TELEPHONE LINE CORD FROM THE WALL.** Then remove the telephone by the unplugged cords.

About cordless telephones

- **Privacy:** The same features that make a cordless telephone convenient create some limitations. Telephone calls are transmitted between the telephone base and the cordless handset by radio waves, so there is a possibility that the cordless telephone conversations could be intercepted by radio receiving equipment within range of the cordless handset. For this reason, you should not think of cordless telephone conversations as being as private as those on corded telephones.
- **Electrical power:** The telephone base of this cordless telephone must be connected to a working electrical outlet. The electrical outlet should not be controlled by a wall switch. Calls cannot be made from the cordless handset if the telephone base is unplugged, switched off or if the electrical power is interrupted.
- **Potential TV interference:** Some cordless telephones operate at frequencies that may cause interference to televisions and VCRs. To minimize or prevent such interference, do not place the telephone base of the cordless telephone near or on top of a TV or VCR. If interference is experienced, moving the cordless telephone farther away from the TV or VCR often reduces or eliminates the interference.
- **Rechargeable batteries:** Exercise care in handling batteries in order not to create a short circuit with conducting material such as rings, bracelets and keys. The battery or conductor may overheat and cause harm. Observe proper polarity between the battery and the battery charger.
- **Nickel-metal hydride rechargeable batteries:** Dispose of these batteries in a safe manner. Do not burn or puncture the battery. Like other batteries of this type, if burned or punctured, they could release caustic material which could cause injury.

Appendix

The RBRC® seal

The RBRC® seal on the nickel-metal hydride battery indicates that VTech Communications, Inc. is voluntarily participating in an industry program to collect and recycle these batteries at the end of their useful lives, when taken out of service within the United States and Canada.

The RBRC® program provides a convenient alternative to placing used nickel-metal hydride batteries into the trash or municipal waste, which may be illegal in your area.

VTech's participation in RBRC® makes it easy for you to drop off the spent battery at local retailers participating in the RBRC® program or at authorized VTech product service centers. Please call **1 (800) 8 BATTERY®** for information on Ni-MH battery recycling and disposal bans/restrictions in your area. VTech's involvement in this program is part of its commitment to protecting our environment and conserving natural resources.

RBRC® and 1 (800) 8 BATTERY® are registered trademarks of the Rechargeable Battery Recycling Corporation.



The RBRC® seal on the lithium-ion battery indicates that VTech Communications, Inc. is voluntarily participating in an industry program to collect and recycle these batteries at the end of their useful lives, when taken out of service within the United States and Canada.

The RBRC® program provides a convenient alternative to placing used lithium-ion batteries into the trash or municipal waste, which may be illegal in your area.

VTech's participation in RBRC® makes it easy for you to drop off the spent battery at local retailers participating in the RBRC® program or at authorized VTech product service centers. Please call **1 (800) 8 BATTERY®** for information on Li-ion battery recycling and disposal bans/restrictions in your area. VTech's involvement in this program is part of its commitment to protecting our environment and conserving natural resources.

RBRC® and 1 (800) 8 BATTERY® are registered trademarks of the Rechargeable Battery Recycling Corporation.



Appendix

FCC, ACTA and IC regulations

FCC Part 15

NOTE: This equipment has been tested and found to comply with the requirements for a Class B digital device under Part 15 of the Federal Communications Commission (FCC) rules. These requirements are intended to provide reasonable protection against harmful interference in a residential installation. This equipment generates, uses and can radiate radio frequency energy and, if not installed and used in accordance with the instructions, may cause harmful interference to radio communications. However, there is no guarantee that interference will not occur in a particular installation. If this equipment does cause harmful interference to radio or television reception, which can be determined by turning the equipment off and on, the user is encouraged to try to correct the interference by one or more of the following measures:

- Reorient or relocate the receiving antenna.
- Increase the separation between the equipment and receiver.
- Connect the equipment into an outlet on a circuit different from that to which the receiver is connected.
- Consult the dealer or an experienced radio/TV technician for help.

WARNING: Changes or modifications to this equipment not expressly approved by the party responsible for compliance could void the user's authority to operate the equipment.

This device complies with Part 15 of the FCC rules. Operation is subject to the following two conditions: (1) this device may not cause harmful interference, and (2) this device must accept any interference received, including interference that may cause undesired operation. Privacy of communications may not be ensured when using this telephone.

To ensure safety of users, the FCC has established criteria for the amount of radio frequency energy that can be safely absorbed by a user or bystander according to the intended usage of the product. This product has been tested and found to comply with the FCC criteria. The handset may be safely held against the ear of the user. The telephone base shall be installed and used such that parts of the user's body other than the hands are maintained at a distance of approximately 20 cm (8 inches) or more.

This Class B digital apparatus complies with Canadian requirement:
CAN ICES-3 (B)/NMB-3(B).

FCC Part 68 and ACTA

This equipment complies with Part 68 of the FCC rules and with technical requirements adopted by the Administrative Council for Terminal Attachments (ACTA). The label on the back or bottom of this equipment contains, among other things, a product identifier in the format US:AAAEQ##TXXXX. This identifier must be provided to your telephone service provider upon request.

The plug and jack used to connect this equipment to premises wiring and the telephone network must comply with applicable Part 68 rules and technical requirements adopted by ACTA. A compliant telephone cord and modular plug is provided with this product. It is designed to be connected to a compatible modular jack that is also compliant. An RJ11 jack should normally be used for connecting to a single line and an RJ14 jack for two lines. See the installation instructions in the user's manual.

The Ringer Equivalence Number (REN) is used to determine how many devices you may connect to your telephone line and still have them ring when you are called. The REN for this product is encoded as the 6th and 7th characters following the US: in the product identifier (e.g., if ## is 03, the REN is 0.3). In most, but not all areas, the sum of all RENs should be five (5.0) or less. For more information, contact your telephone service provider.

This equipment may not be used with Party Lines. If you have specially wired alarm dialing equipment connected to your telephone line, ensure the connection of this equipment does not disable your alarm equipment. If you have questions about what will disable alarm equipment, consult your telephone service provider or a qualified installer.

If this equipment is malfunctioning, it must be unplugged from the modular jack until the problem has been corrected. Repairs to this telephone equipment can only be made by the manufacturer or its authorized agents. For repair procedures, follow the instructions outlined under the Limited warranty.

Appendix

FCC, ACTA and IC regulations

If this equipment is causing harm to the telephone network, the telephone service provider may temporarily discontinue your telephone service. The telephone service provider is required to notify you before interrupting service. If advance notice is not practical, you will be notified as soon as possible. You will be given the opportunity to correct the problem and the telephone service provider is required to inform you of your right to file a complaint with the FCC. Your telephone service provider may make changes in its facilities, equipment, operation, or procedures that could affect the proper functioning of this product. The telephone service provider is required to notify you if such changes are planned.

If this product is equipped with a corded or cordless handset, it is hearing aid compatible.

If this product has memory dialing locations, you may choose to store emergency telephone numbers (e.g., police, fire, medical) in these locations. If you do store or test emergency numbers, please:

Remain on the line and briefly explain the reason for the call before hanging up.

Perform such activities in off-peak hours, such as early morning or late evening.

Industry Canada

This device complies with Industry Canada licence-exempt RSS standard(s).

Operation is subject to the following two conditions: (1) this device may not cause harmful interference, and (2) this device must accept any interference received, including interference that may cause undesired operation.

Privacy of communications may not be ensured when using this telephone.

The term "IC:" before the certification/registration number only signifies that the Industry Canada technical specifications were met.

The Ringer Equivalence Number (REN) for this terminal equipment is 1.0. The REN indicates the maximum number of devices allowed to be connected to a telephone interface. The termination of an interface may consist of any combination of devices subject only to the requirement that the sum of the RENs of all the devices does not exceed five.

This product meets the applicable Innovation, Science and Economic Development Canada technical specifications.

Appendix

California Energy Commission battery charging testing instructions

This telephone is set up to comply with the energy-conserving standards right out of the box. These instructions are intended for California Energy Commission (CEC) compliance testing only.

When the CEC battery charging testing mode is activated, all headset functions, except battery charging, will be disabled.

To activate the CEC battery charging testing mode:

1. Unplug the telephone base power adapter from the power outlet. Make sure all handsets are plugged with charged batteries before proceeding.
2. While you press and hold **FIND HANDSET**, plug the telephone base power adapter back to the power outlet.
3. After about 20 seconds, when the **IN USE** light starts flashing, release **FIND HANDSET** and then press it again within 2 seconds.

When the phone successfully enters the CEC battery charging testing mode, the **IN USE** light turns off and all handsets display **To register HS, see manual**.

When the phone fails to enter this mode, repeat Step 1 through Step 3 above.

note

The telephone base will be powered up as normal if you fail to press **FIND HANDSET** within 2 seconds in Step 3.

To deactivate the CEC battery charging testing mode:

1. Unplug the telephone base power adapter from the power outlet, and then plug it back in. Then the telephone base is powered up as normal.
2. Place the handset in the telephone base to register it back. The handset displays **Registering...Please wait** and the red **IN USE** light on the telephone base turns on. |

note

The handset shows **HANDSET X Registered** and you hear a beep when the registration process completes. The registration process takes about 90 seconds to complete.

Appendix

For C-UL compliance only

Mesures de sécurité importantes

Afin de réduire les risques d'incendie, de blessures corporelles ou d'électrocution, suivez toujours ces mesures préventives de base lorsque vous utilisez votre téléphone :

1. Lisez et comprenez bien toutes les instructions.
2. Observez toutes les instructions et mises en garde inscrites sur l'appareil.
3. Débranchez ce téléphone de la prise murale avant de le nettoyer. N'utilisez pas de nettoyeurs liquides ni en aérosol. N'utilisez qu'un chiffon doux et légèrement humecté.
4. N'utilisez pas ce produit près de l'eau, tel que près d'un bain, d'un lavabo, d'un évier de cuisine, d'un bac de lavage ou d'une piscine, ou dans un sous-sol humide ou sous la douche.
5. Ne déposez pas ce téléphone sur un chariot, support ou table chancelants. L'appareil pourrait tomber et être sérieusement endommagé.
6. Évitez d'installer le système téléphonique dans les endroits soumis à une température extrême, à la lumière directe du soleil ou à proximité immédiate d'autres appareils électriques ou électroniques. Protégez votre téléphone contre les sources d'humidité, la poussière, les vapeurs et les liquides corrosifs.
7. Le boîtier de l'appareil est doté de fentes et d'ouvertures d'aération situées à l'arrière ou en dessous. Afin d'empêcher la surchauffe, ces ouvertures ne doivent pas être obstruées en plaçant l'appareil sur un lit, divan, tapis ou autre surface similaires. Ne placez pas cet appareil à proximité d'un élément de chauffage ni d'une plinthe électrique. De plus, ne l'installez pas dans une unité murale ou un cabinet fermé qui ne possède pas d'aération adéquate.
8. Ne faites fonctionner cet appareil qu'avec le type d'alimentation indiqué sur les étiquettes de l'appareil. Si vous ne connaissez pas le voltage de votre maison, consultez votre marchand ou votre fournisseur d'électricité.
9. Ne déposez rien sur le cordon d'alimentation. Installez cet appareil dans un endroit sécuritaire, là où personne ne pourra trébucher sur la ligne d'alimentation ni le cordon téléphonique modulaire.
10. N'insérez jamais d'objets à travers les fentes et ouvertures de cet appareil, car ils pourraient toucher à des points de tension dangereux ou court-circuiter des pièces, ce qui constituerait un risque d'incendie ou d'électrocution. N'échappez pas de liquides dans l'appareil.
11. Afin de réduire les risques d'électrocution, ne démontez pas l'appareil, mais apportez-le plutôt à un centre de service qualifié s'il doit être réparé. En enlevant le couvercle, vous vous exposez à des tensions dangereuses ou autres dangers similaires. Un remontage inadéquat peut être à l'origine d'une électrocution lors d'une utilisation ultérieure de l'appareil. Débranchez l'appareil avant de procéder au nettoyage. Utilisez un chiffon humide et doux.
12. Ne surchargez pas les prises de courant et les rallonges.
13. Débranchez cet appareil de la prise de courant et communiquez avec le département de service à la clientèle de VTech dans les cas suivants:
 - Lorsque le cordon d'alimentation est endommagé ou écorché.
 - Si du liquide a été échappé dans l'appareil.
 - Si l'appareil a été exposé à une source d'humidité telle que la pluie ou l'eau.
 - Si le produit ne fonctionne pas normalement en respectant les instructions de fonctionnement. Réglez uniquement les commandes indiquées dans les instructions de fonctionnement. Les réglages incorrects des autres commandes pourraient provoquer un dommage qui pourrait exiger un travail exhaustif de la part d'un technicien autorisé afin de rétablir le fonctionnement normal de l'appareil.
 - Si le produit a été échappé et que le socle et/ou le combiné a été endommagé.
 - Si le produit affiche une nette diminution de sa performance.
14. Évitez d'utiliser un téléphone (autre qu'un sans fil) pendant un orage. Les éclairs peuvent être à l'origine d'une électrocution.
15. N'utilisez pas le téléphone pour rapporter une fuite de gaz à proximité de la fuite. En certaines circonstances, une flammèche pourrait être provoquée lorsque l'adaptateur est branché à une prise de courant, ou lorsque le combiné est déposé sur le socle. Ceci est un événement commun associé à la fermeture d'un circuit électrique. L'utilisateur ne devrait pas brancher le téléphone à une prise de courant, et ne devrait pas déposer le combiné chargé sur le socle, si le téléphone se trouve à proximité d'un endroit comportant des concentrations de gaz inflammables, à moins que la ventilation soit adéquate. Une flammèche dans un tel endroit pourrait provoquer un incendie ou une explosion. De tels environnements peuvent comprendre: des endroits où l'on utilise de l'oxygène médical sans ventilation adéquate; des gaz industriels (dissolvants de nettoyage, des vapeurs d'essence, etc.); une fuite de gaz naturel, etc.
16. Ne placez que le combiné de votre téléphone près de votre oreille lorsqu'en mode de conversation.

Appendix

For C-UL compliance only

17. Ces adaptateurs ont été conçus pour être orientés en position verticale ou montés au sol. Les broches ne sont pas conçues pour maintenir l'adaptateur en place si celui-ci est barnché dans une prise au plafond ou sous une table/ armoire.
18. Pour le MATERIEL RACCORDE PAR PRISE DE COURANT, le socle de prise de courant doit être installé à proximité du matériel et doit être aisément accessible.

CONSERVEZ CES INSTRUCTIONS

Pile

- MISE EN GARDE : N'utilisez que la pile incluse.
- Ne jetez pas la pile au feu. Vérifiez les instructions spécifiques de mise aux rebus auprès des autorités locales.
- N'ouvrez pas et ne mutilez pas la pile. L'électrolyte qui s'en échapperait est corrosif et pourrait causer des brûlures ou des blessures aux yeux ou à la peau. L'électrolyte est toxique si avalé.
- Soyez prudents lorsque vous manipulez les piles afin d'éviter les courts-circuits provoqués par des matériaux conducteurs.
- Rechargez la pile incluse avec cet appareil, selon les instructions et limites spécifiées dans ce guide d'utilisation.

Stimulateurs cardiaques implantés dans l'organisme

Les simulateurs cardiaques (s'applique uniquement aux téléphones numériques sans fil):

L'organisme 'Wireless Technology Research, LLC (WTR)', une firme de recherche indépendante, a mené une évaluation pluridisciplinaire des interférences entre les téléphones sans fil portatifs et les stimulateurs cardiaques implantés dans l'organisme. Appuyée par l'Administration des aliments et drogues (FDA) des États-Unis, la firme WTR recommande aux médecins:

Avis aux détenteurs de stimulateurs cardiaques

- Ils doivent tenir le téléphone sans fil à une distance d'au moins six pouces du stimulateur cardiaque.
- Ils ne doivent PAS placer le téléphone sans fil directement sur le stimulateur cardiaque, tel que dans une poche de chemise, lorsque celui-ci est en marche.
- Ils doivent utiliser le téléphone sans fil en l'appuyant sur l'oreille qui se trouve dans la direction opposée au stimulateur cardiaque.

L'étude effectuée par l'organisme WRS n'a pas identifié de risque pour les détenteurs de simulateurs cardiaques causés par les gens qui utilisent un téléphone sans fil à proximité de ceux-ci.

À propos des téléphones sans fil

- **Alimentation électrique:** Les mêmes caractéristiques qui constituent des avantages pour les téléphones sans fil affichent également des restrictions. Les appels téléphoniques sont transmis entre le combiné sans fil et le socle par le biais d'ondes radio ; il y a donc la possibilité que vos conversations téléphoniques sans fil soient interceptées par des équipements de réception radio se trouvant dans la portée du combiné sans fil. Pour cette raison, vous ne devez pas percevoir les communications téléphoniques sans fil comme étant aussi confidentielles.
- **Alimentation électrique:** Le socle de ce téléphone sans fil doit être branché à une prise électrique fonctionnelle. La prise électrique ne doit pas être contrôlée par un interrupteur mural. Les appels ne pourront pas être effectués du combiné sans fil si le socle est débranché ou mis hors tension ou si le courant est coupé.
- **Possibilité d'interférences aux téléviseurs:** Certains téléphones sans fil fonctionnent sur des fréquences pouvant causer des interférences aux téléviseurs et aux magnétoscopes. Pour réduire ou prévenir de telles interférences, ne placez pas le socle du téléphone sans fil près ou sur un téléviseur ou magnétoscope. S'il y a présence de parasites, il est conseillé d'éloigner le téléphone sans fil du téléviseur ou du magnétoscope afin de réduire possiblement les interférences.
- **Piles rechargeables:** Manipulez les piles avec soin afin de ne pas les court-circuiter avec des bagues, bracelets ou clés. Les piles ou le conducteur peut surchauffer et causer des blessures. Respectez la polarité adéquate entre la pile et le chargeur.
- **Les bloc-piles rechargeables à l'hydrure métallique de nickel:** Jetez ces blocs-piles de manière écologique et sécuritaire. Ne les incinerez pas et ne les percez pas. Tel que les autres piles de ce type, elles pourraient dégager une matière toxique qui peut causer des blessures corporelles si elles sont brûlées ou percées.

Appendix

Limited warranty

What does this limited warranty cover?

The manufacturer of this VTech Product warrants to the holder of a valid proof of purchase (“Consumer” or “you”) that the Product and all accessories provided in the sales package (“Product”) are free from defects in material and workmanship, pursuant to the following terms and conditions, when installed and used normally and in accordance with the Product operating instructions. This limited warranty extends only to the Consumer for Products purchased and used in the United States of America and Canada.

What will VTech do if the Product is not free from defects in materials and workmanship during the limited warranty period (“Materially Defective Product”)?

During the limited warranty period, VTech’s authorized service representative will repair or replace at VTech’s option, without charge, a Materially Defective Product. If we repair the Product, we may use new or refurbished replacement parts. If we choose to replace the Product, we may replace it with a new or refurbished Product of the same or similar design. We will retain defective parts, modules, or equipment. Repair or replacement of the Product, at VTech’s option, is your exclusive remedy. VTech will return the repaired or replacement Products to you in working condition. You should expect the repair or replacement to take approximately 30 days.

How long is the limited warranty period?

The limited warranty period for the Product extends for ONE (1) YEAR from the date of purchase. If VTech repairs or replaces a Materially Defective Product under the terms of this limited warranty, this limited warranty also applies to the repaired or replacement Product for a period of either (a) 90 days from the date the repaired or replacement Product is shipped to you or (b) the time remaining on the original one-year warranty; whichever is longer.

What is not covered by this limited warranty?

This limited warranty does not cover:

1. Product that has been subjected to misuse, accident, shipping or other physical damage, improper installation, abnormal operation or handling, neglect, inundation, fire, water or other liquid intrusion; or
2. Product that has been damaged due to repair, alteration or modification by anyone other than an authorized service representative of VTech; or
3. Product to the extent that the problem experienced is caused by signal conditions, network reliability, or cable or antenna systems; or
4. Product to the extent that the problem is caused by use with non-VTech accessories; or
5. Product whose warranty/quality stickers, product serial number plates or electronic serial numbers have been removed, altered or rendered illegible; or
6. Product purchased, used, serviced, or shipped for repair from outside the United States of America or Canada, or used for commercial or institutional purposes (including but not limited to Products used for rental purposes); or
7. Product returned without a valid proof of purchase (see item 2 on the next page); or
8. Charges for installation or set up, adjustment of customer controls, and installation or repair of systems outside the unit.

Appendix

Limited warranty

How do you get warranty service?

To obtain warranty service in the United States of America, please visit our website at www.vtechphones.com or call 1 (800) 595-9511. In Canada, go to www.vtechcanada.com or dial 1 (800) 267-7377.

NOTE: Before calling for service, please review the user's manual - a check of the Product's controls and features may save you a service call.

Except as provided by applicable law, you assume the risk of loss or damage during transit and transportation and are responsible for delivery or handling charges incurred in the transport of the Product(s) to the service location. VTech will return repaired or replaced Product under this limited warranty. Transportation, delivery or handling charges are prepaid. VTech assumes no risk for damage or loss of the Product in transit. If the Product failure is not covered by this limited warranty, or proof of purchase does not meet the terms of this limited warranty, VTech will notify you and will request that you authorize the cost of repair prior to any further repair activity. You must pay for the cost of repair and return shipping costs for the repair of Products that are not covered by this **limited warranty**.

What must you return with the Product to get warranty service?

1. Return the entire original package and contents including the Product to the VTech service location along with a description of the malfunction or difficulty; and
2. Include a "valid proof of purchase" (sales receipt) identifying the Product purchased (Product model) and the date of purchase or receipt; and
3. Provide your name, complete and correct mailing address, and telephone number.

Other limitations

This warranty is the complete and exclusive agreement between you and VTech. It supersedes all other written or oral communications related to this Product. VTech provides no other warranties for this Product. The warranty exclusively describes all of VTech's responsibilities regarding the Product. There are no other express warranties. No one is authorized to make modifications to this limited warranty and you should not rely on any such modification.

State/Provincial Law Rights: This warranty gives you specific legal rights, and you may also have other rights, which vary from state to state or province to province.

Limitations: Implied warranties, including those of fitness for a particular purpose and merchantability (an unwritten warranty that the Product is fit for ordinary use) are limited to one year from the date of purchase. Some states/provinces do not allow limitations on how long an implied warranty lasts, so the above limitation may not apply to you. In no event shall VTech be liable for any indirect, special, incidental, consequential, or similar damages (including, but not limited to lost profits or revenue, inability to use the Product or other associated equipment, the cost of substitute equipment, and claims by third parties) resulting from the use of this Product. Some states/provinces do not allow the exclusion or limitation of incidental or consequential damages, so the above limitation or exclusion may not apply to you.

Please retain your original sales receipt as proof of purchase.

Appendix

Technical specifications

Frequency control	Crystal controlled PLL synthesizer
Transmit frequency	DECT frequency: 1921.536-1928.448 MHz Bluetooth frequency: 2402.000-2480.000 MHz
Channels	DECT: 5 Bluetooth: 79
Nominal effective range	Maximum power allowed by FCC and IC. Actual operating range may vary according to the environmental conditions at the time of use.
Power requirements	Handset: 2.4V Ni-MH battery Telephone base: Output #1: 6V DC @ 450mA; Output #2: 6V DC @ 300mA Charger: 6V AC @ 300mA
Memory	Home phonebook: 200 memory locations; up to 30 digits and 15 characters Cell phonebooks (2): 1000 memory locations (each); up to 30 digits and 15 characters Caller ID log: 50 memory locations; up to 24 digits and 15 characters

Index

A

- Add a cell phone 25
- Add a handset 75
- Add a headset 76
- Add a phonebook entry 53–54
- Alphabetical search 55
- Announcement 64–65
- Answer a call 36, 37, 38
- Answer an incoming call during a PTT call 51
- Answer a PTT call 50
- Answering system 64–74
- Answering system and voicemail 69
- Answering system settings 64–68
- Answer on/off 65

B

- Battery 3, 4, 6, 95
- Bluetooth 21–27
- Bluetooth glossary 23
- Bluetooth setup 24

C

- Call screening 66, 67
- Call waiting 36, 38
- Caller ID 58–63
- Caller ID log 59
- Caller ID log messages 63
- Cell call 37–38
- Cell phone - download phonebook 27
- Chain dialing 41
- Charging 4–5
- CID time synchronization 35
- Clock 31
- Connect a paired cell phone 26
- Connect to Cell 24

D

- Date and time 31
- Delete a caller ID log entry 63
- Delete a phonebook entry 57
- Delete a redial entry 40
- Delete messages 72, 73
- Delete the announcement 65
- Deregister handsets/headsets 77
- Dial a caller ID log entry 62
- Dial a phonebook entry 56
- Dial a redial entry 40
- Dialing options 61
- Dial mode 35, 42
- Download phonebook 27
- DSL filter 2

E

- Ear hook installation 8–10
- Earbud installation 7
- ECO mode 95
- Edit a phonebook entry 56
- End a call 36, 37
- Expand your telephone system 75

F

- FCC, ACTA and IC regulations 98–100
- Find handset 42
- Flash 36, 38

H

- Handset battery charging 4
- Handset battery installation 3
- Handset icons 82
- Handset layout 15–17
- Handset lights 81
- Handset locator 42
- Head band installation 11–12
- Headset charging 5
- Headset layout 20
- Headset lights 83
- Headset ringer volume 29
- Hold 39
- Home call 36

I

- Icons 82
- Indicators 81–82, 83
- Installation 2–3, 7–12
- Intercom 44–46

J

- Join a call 43

K

- Key tone 34

L

- Language 32
- Layout 15–20
- Lights 81, 83
- Limited warranty 103–104

M

- Maintenance 96
- Make a call 36, 37
- Make an outgoing call during a PTT call 51
- Memo 73
- Memory match 59

Index

Menu 28
Message alert tone 67
Message playback 72
Message window displays 78
Missed call indicator 60
Multiple handsets 43–51
Mute 39

N

Number of rings 66

O

Operating range 95
Operations 36–42, 69–74

P

Pacemakers 95
Paging 42
Pair and connect a cell phone 25
Parts checklist 1
Phonebook 27, 52–57
PIN 23, 25
Predial 36
PTT on or off 47
PTT to a single handset 48
PTT to multiple handsets 49
Push-to-talk (PTT) 47–51

Q

Quiet mode 30

R

Record an announcement 64
Recording time 68
Record memos 73
Redial 40
Register a handset 75
Register a headset 76
Registration 75–76
Remote access 67, 74
Remove a downloaded phonebook 57
Review a phonebook 55
Review the caller ID log 60
Review the redial list 40
Ringer tone 30
Ringer volume 29

S

Safety instructions 94
Save a caller ID log entry 62
Screen messages 63, 79–80
Settings 28–35, 64–68
Share an outside call 43

Silence the ringer 41
Speakerphone 38

T

Technical specifications 105
Telephone base layout 18–19
Telephone base lights 81
Temporary ringer silencing 41
Temporary tone dialing 42
Transfer a call 46
Troubleshooting 84–93
Turn on or off the answering system 65

U

Using the menu 28

V

Voicemail 33, 34, 38, 42, 69
Voicemail indicators 34
Volume 29, 39

W

Warranty 103–104
Website 40

The *Bluetooth*® word mark and logos are owned by Bluetooth SIG, Inc. and any use of such marks by VTech Holdings Limited is under license. VTech Holdings Limited is a member of Bluetooth SIG, Inc. Other trademarks and trade names are those of their respective owners.



Designed to fit your home.
And your life.

VTech Communications, Inc.

A member of THE VTECH GROUP OF COMPANIES.

VTech is a registered trademark of VTech Holdings Limited.

Specifications are subject to change without notice.

Copyright © 2016 for VTech Communications, Inc.

All rights reserved. 08/16. DS6671-X_WEBCIB_V5.0

Document order number: 91-007300-040-100

